

FUN*da*MENTALS of Design

Topic 2 Creating Ideas

Creating Ideas

It is every design engineer's goal to successfully transition from rough sketch to successful product. Indeed, anyone can generate ideas, all you have to do is start thinking combinatorially: Linear motion requires bearings and actuators, so list all the different types of bearings, all the different types of actuators, all the different types of mechanisms, and then put them together in every possible combination. *Theo-hopeful-retically* this will result in a great idea that lets you rule!

When creating a non-critical *module* for a more complex machine, this is often adequate. In fact, when a new machine has some critical awesome *module* that will ensure your market domination, you do not want to use risky nifty new ideas to open a door; because if the door breaks, the entire machine will be in trouble. Hence you need to be able to generate robust and low-to-zero risk ideas for some modules while creating awesome new ideas for other *modules*.

Awesome new *concepts* are not necessarily *generated*, they are often *created*. Creative ideas often come about by considering not only all different types of *components* and mechanisms, but by careful consideration of the physics of the system, and in particular, of the functional requirements for the design. Sometimes,

the physics has nothing to do with the initial idea, which instead may be driven by environmental or ergonomic concerns. For example, getting chips away from the cutting process can be as important as the cutting process itself. In abrasive waterjet machining, where a high pressure waterjet carries an abrasive grit to cut the material, the grit can be extremely punishing to actuators or bearings that are not well-sealed.

The design of robots is of particular interest, because packing more power and dexterity in a smaller and smaller package is the goal. Some feel that nature has done the ultimate job, and thus the future of robotics lies in the use of cables (tendons) and actuators (muscles) working in concert with distributed microcontrollers and sensors (brains and nerves). Others believe that to emulate humans is not the point of robotics, and that robots should be designed for specific tasks. Others believe all these views are correct and that the real goal is to generate and create new robots, because geeks just wanna have fun!

And through it all, one must act ethically and professionally. Ethics and professionalism are not just about what you should do in a situation, they are about looking ahead to prevent problems in the first place!

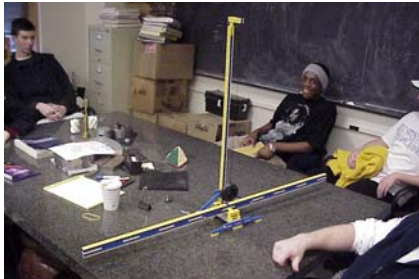

Topic 2 Creating Ideas



Topics

- Creation: Coarse-to-Fine
- Thought Processes
- Experimentation
- Drawing
- Research
- Writing
- Analysis
- Evolving Ideas

“Curiosity is one of the permanent and certain characteristics of a vigorous mind” – Samuel Johnson

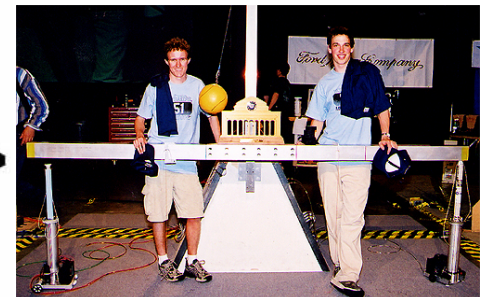
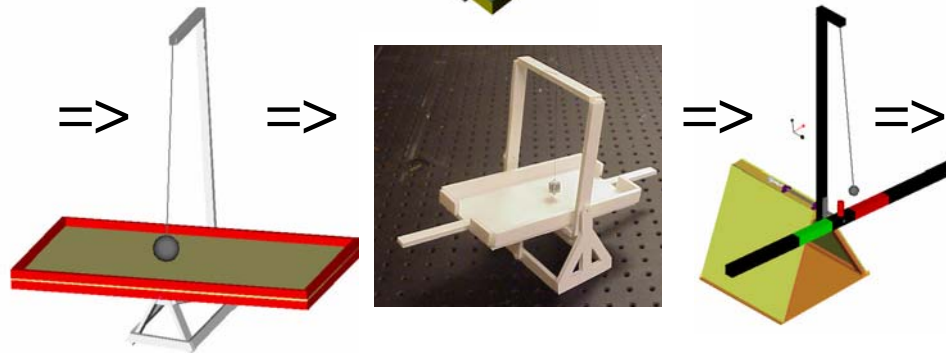
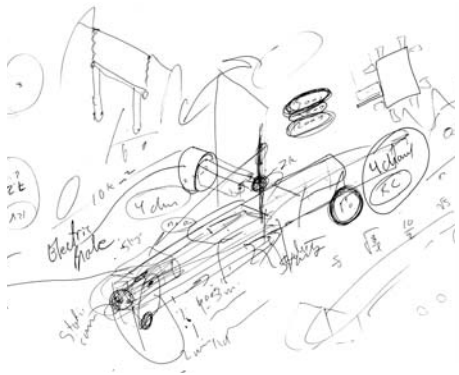
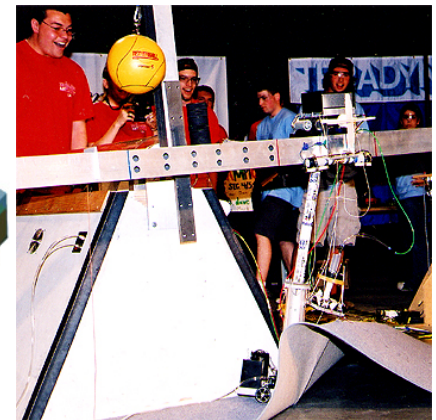
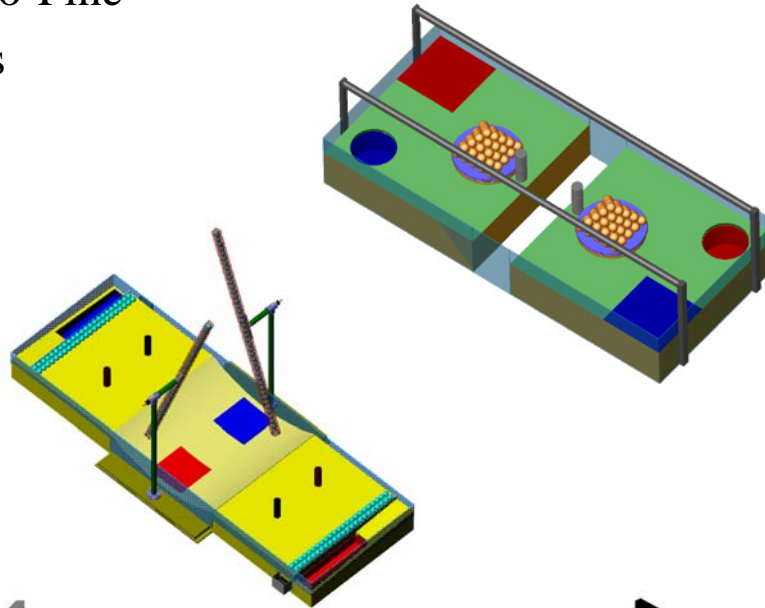

Creation: Coarse-to-fine

Coarse-to-fine is a powerful philosophy analogous to creating an outline for a written document. You first think of the major chapters, then sections within the chapters, and then subsections. Finally, you write introductory paragraphs for each section to gather thoughts and define the theme. In any major design project, this creation of an outline helps to look forward to the needs of a project and design team. It can help overcome some of the major mistakes made by design engineers and managers:

Early on in a design, engineers can get too hung up on details, and never think of creative solutions because they worry too much....

Early on in a design, engineers can get too hung up on being creative, and never think of reality because they do not worry about it....

Teams of engineers can mistakenly assume that management has built a team with the variety and depth of experience required.

Early on in a design, engineers might think all issues can be addressed by teamwork, and worse yet, that someone else on the team can always handle the difficult tasks.

Clearly there are some fundamental contradictions, but if everyone is assuming someone else knows what to do, then there is the potential for a scenario like in the famous story about the emperor's new clothes!

The FRDPARRC sheets described in Topic 1 along with the philosophy of development by **strategy, concept, modules, components & elements** can serve as a powerful aid for developing the outline of a design plan. As the details emerge, they can fill in the picture of the entire design, and provide visual clues as to what might be missing.

To demonstrate these ideas, compare the process to feeding friends:

Strategies include going to a restaurant, having the meal catered, cooking a meal yourself, or having a pot-luck dinner. Assume you decide to cook the meal yourself.

Concepts include the type of meal as well as the preparation style. For example: BBQ, ala carte, or sit-down and serve. Assume a traditional sit down and serve dinner is decided upon.

Modules include the different dishes, such as roast beef, garlic mashed potatoes, vegetarian lasagne, asparagus, lots of avocados, salad, and fresh-baked bread.

Components & elements include the individual ingredients.

You would ideally never think of deciding to host a dinner and then just start rummaging through the refrigerator and cupboards to start the meal a couple of hours before everyone arrived. Likewise, you probably would not worry about trying to query your guests beforehand about exactly how much of each type of food they will be eating, and then determining *exactly* how much of each ingredient would be required

Planning a design can be like planning a party. You have to start by making some broad assumptions that enable you to then plan the next level of detail. Finally you can order all the stuff and then start setting up and preparing. You must make some initial estimates based on what you think is a reasonable level of detail. As time moves along, you get more and more detailed information which allows you to refine and better execute your plan. Meanwhile, you must keep in mind all the other commitments you have in your life, and keep things balanced and in perspective.

Creating a new design is fun and straightforward. In fact, according to Edwin Land, the brilliant founder of Polaroid Corp., *Creativity is the cessation of stupidity.*

Make a clear, calm and concise assessment of the major commitments in your life, and try to arrive at an honest and objective estimate of the time per week you will be able to spend on your project. As your project develops, this will be a continuing exercise you can do to help you decide when to implement countermeasures. It can also help to identify simply things to enable you to meet your commitments in an effective and timely manner.

Creation: Coarse-to-Fine

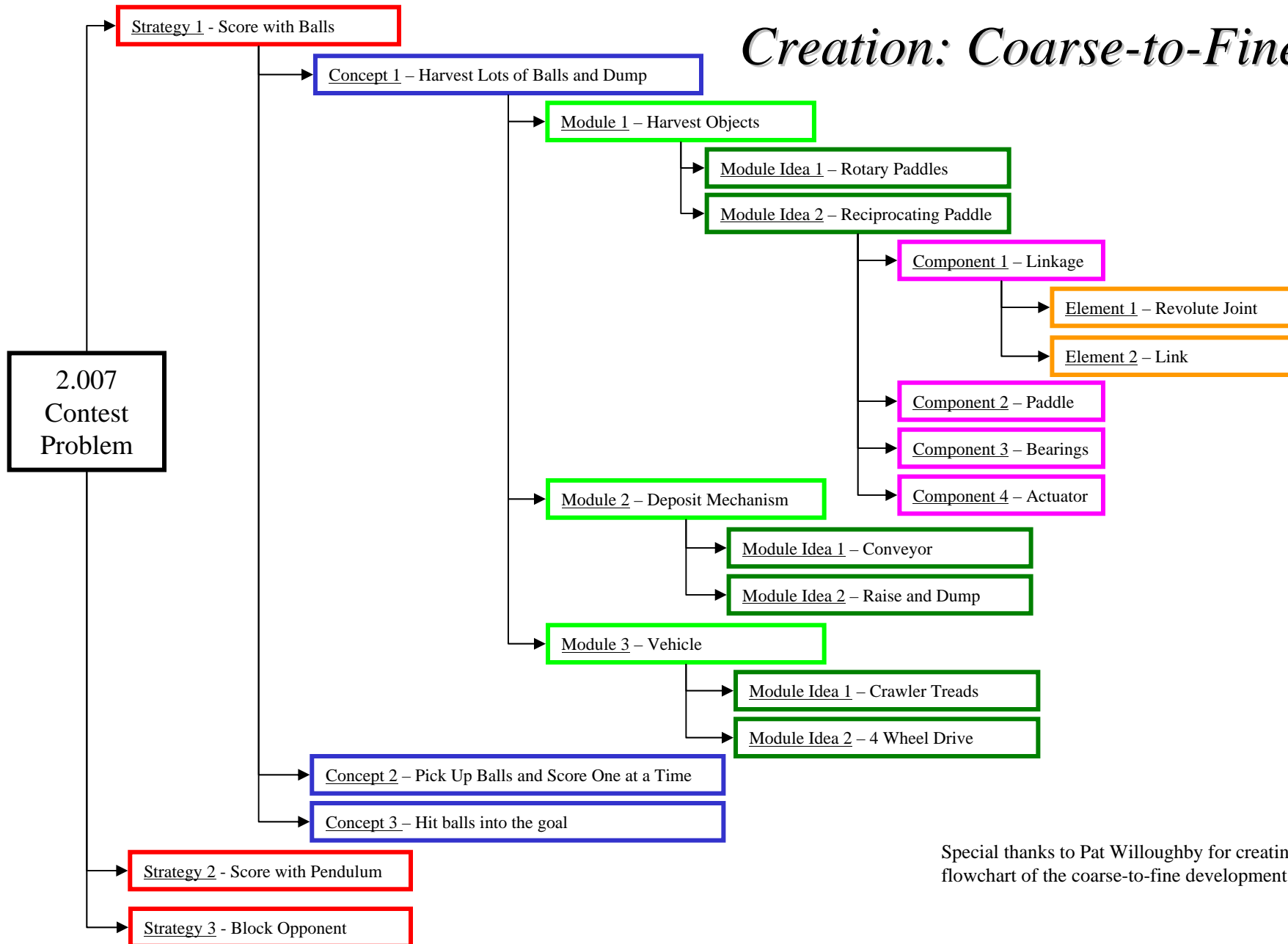

Special thanks to Pat Willoughby for creating this flowchart of the coarse-to-fine development process

Thought Processes

Deterministic design and the scientific method are powerful methods for attacking problems. In fact, both of these methods act as catalysts for design processes, which as discussed previously can often be thought of as a series of **Coarse-to-fine** activities. Accordingly, there are many different types of *Thought Processes* which can be used to get the creative juices flowing, and your task is to cycle through the different ones (and create your own!) until you get a clear vision of the solution.

Think of any step in the design process as trying to clearly see all the features of a large complex statue. You cannot see everything from one side so walk around it and systematically look at it from many different perspectives. *Systematic Variation* is a powerful tool for looking at problems and solutions from different perspectives. It involves first identifying all the elements of the problem, or the elements available for use in the solution. Next, one systematically varies each of the parameters, in terms of its function and how it may be combined with other elements. If you wiggle all possible parameters and take note of the effect, you are likely to find parameters on which to focus. Wiggle methods include persistent questioning and sensitivity studies. Continually ask: Who? What? Why? Where? How? Can I?

- Who wants this thing? Who put it here? Who really cares?
- What is this thing? What does it do, or what would happen if it was deleted? What would happen if it was changed (bigger, smaller)? What types of solutions exist to subsets of this problem?
- Why is this thing here? Why does it have its shape? Why do I really need it? Why does someone else really need it?
- Where did this thing come from? Where else can it go? Where is the best place for it?
- How did this thing get here? How can I get rid of it? How can I change it? How hard will it be to change? How can I make it better?
- Can I change it? Can I get rid of it? Can I move it? Can I modify it? Can I substitute something else for it? Can I make it better?

Sometimes no matter how hard you look at something, you just cannot figure out what it is. In this situation, you might want to try to make an assumption about what it is, and then with your assumption in mind, see if it

indeed matches what you were looking at. This is called *reversal*, and as we shall also see in the next chapter, it has many powerful engineering applications as well. Applying *reversal* to itself, we see that there are two paths to take: *Forward Steps* and *Backwards Steps*: *Forward Steps* starts with observation of a problem and the application of *Systematic Variation* to help you identify all the nuances of the problem, and in doing so, it should help you identify solution paths. In other words, start with an idea, and vary it in as many ways as possible to create different ideas, until each one gets to the end goal.

With *Backwards Steps* you assume a solution, envision the end result of your work, and then apply *Systematic Variation* to your solution to work your way backwards to the beginning to discover all the details. For example, in a geometry problem, write the last line of a proof. In a robot design contest, draw the last scene of the contest to show the final state of the contest area, and then sketch the strategy that could have made it happen. In other words, start with the end goal and work backwards along as many paths as possible until you get to the beginning.

Your brain is a natural neural net, a biological construct that *Nature* evolved to solve complex problems. If you are stuck, apply reversal to yourself and ask yourself *has Nature already solved this type of problem before, or does something in Nature offer a solution?* Velcro™ was supposedly invented by a hiker picking burrs off his socks, and it came to him that this would be a great idea for a fastener. Composite materials are inspired by bird bones, and the list goes on and on. Finally, consider the method of *Exact Constraints*: What is the absolute minimum possible solution to the problem to just exactly define it?

Successful designers have these and other thought processes hard-wired into their bio neural nets. Whenever they are faced with a problem, or they are in need of a solution, their neurons fire until they achieve design happiness. Got wiring? Start your wiring today!

Apply systematic variation to the contest table and to your favorite **strategies**, **concepts**, and **modules**. Any changes result? Sketch or otherwise describe the final state in which you would like to see the contest table? If you could have scored any way you would have wanted, what would the final situation look like? Could any of your **strategies** lead you to the final state?

Thought Processes

- **"Personal self-satisfaction is the death of the scientist. Collective self-satisfaction is the the death of research. It is restlessness, anxiety, dissatisfaction, agony of the mind that nourish science"** *Jacques-Lucien Monod*
- To help generate and create ideas, *thought processes* can be used as *catalysts*
 - Systematic Variation
 - Consider all possibilities
 - Persistent Questioning
 - Continually ask “Who?”, “What?”, “Why?”, “Where”, “How?”
 - Reversal: Forward Steps
 - Start with an idea, and vary it in as many ways as possible to create different ideas, until each gets to the end goal
 - Also called the *method of divergent thought*
 - Reversal: Backwards Steps
 - Start with the end goal and work backwards along as many paths as possible till you get to the beginning
 - Nature’s Way
 - How would nature solve the problem?
 - Exact Constraints
 - What are the minimum requirements

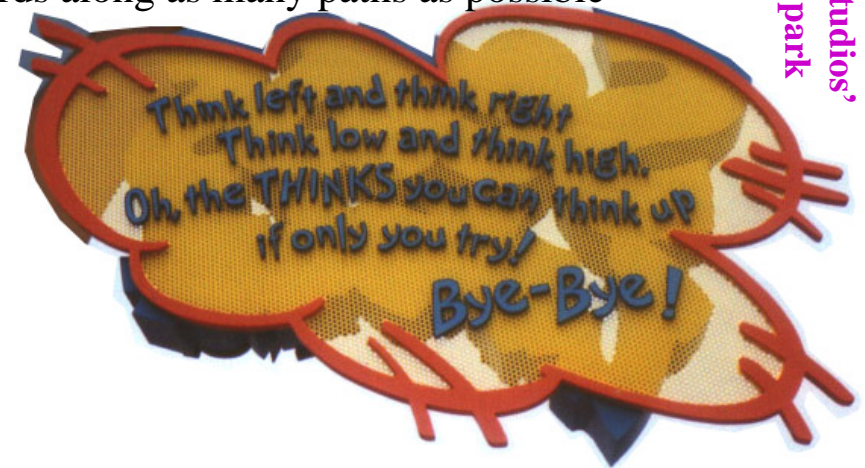

Thought Processes: *Systematic Variation*

Systematic Variation invokes questioning as a means to discover ideas. But about what do we ask the questions "Who?", "What?", "Why?", "Where?", "How?", "Can I"? The answer depends on the type of system you are dealing with, but the method applies to all types of systems from mechanical to software to biological to electrical to chemical to mathematical. For systems such as robots, for example, the principal areas to consider are: *Energy*, *Materials*, *Motions*, and *Controls*.

All physical systems are subject to the actions of energy, and the goal in design is to decide how to use energy to change the system. Asking yourself questions related to energy may lead to answers. Energy can be applied, generated, or stored. Each of these conditions should thus be investigated with respect to the problem or the solution by considering the different methods for accomplishing these effects and apply the method of *Systematic Variation*:

- *Mechanical*: springs, flywheels, elevated masses in a gravitational field (e.g., pendulums)...
 - Hydraulic: pistons, bladders, reservoirs, propellers (turbines)...
- *Electrical*: line source, generator, battery, capacitor, magnet, optical, solar, piezoelectric, magnetostrictive...
- *Chemical*: phase-change, exothermic, endothermic...

Systematic Variation can also be applied to see how different materials or their states can either provide or enhance the solution to a problem:

- Types of materials include metals, plastics, glasses, ceramics, fibers, woods, composites, inorganics, organics, biological, earth, stone
- States of materials include: solid, liquid, gas, mixed phase
- Behavior of materials includes rigid, elastic, plastic, viscous, Newtonian, non-Newtonian
- Form of materials available (bar, sheet, powder...) or amorphous

All physical systems have *geometry* and *motion*, even if their motions are geologic. *Systematic Variation* can help determine how to take advantage of this fact when considering the possible types of motions that can occur:

- Types of motions include fixed (apparently), linear, and rotary
 - Spherical motion is just two rotary motion axes that intersect
- Nature of motion includes uniform, non-uniform, continuous, intermittent (but periodic), transient, random, linear, non-linear...
- Direction & Magnitude
- Symmetry: Can oscillations be controlled or used to your advantage?
- Static: What are the physical boundaries to the problem, and what are the physical boundaries to different components? What are all the ways the design puzzle pieces might fit (like playing Tetris™!)

All physical systems that move also do so for a particular reason, be it due to passive or active control:

- Passive control is where the motions are governed by the physical laws of the universe that govern interaction between particles:
 - Understanding the laws of physics and engineering provide invaluable insight to otherwise seemingly intractable problems
- Active control involves the use of a control system to purposefully change the state of a system to suit the needs of the operator:
 - Open-loop systems send a control signal to the system to apply energy and assume that no more than a single corrective action is required
 - Analogous to turning on the shower with the faucets set to the same position they were at the last time, and then jumping into the shower without first testing the water temperature
 - Closed-loop systems sense the state of the system and then send control signals to change the energy flow into the system until the system achieves the desired state within allowable tolerances.

Models of physical systems, be they analytical, mental, or physical, are invaluable for they allow you to systematically vary parameters for a minimum cost in terms of resources and time.

Think of the above physical effects in the context of the contest table and your favorite *strategies*, *concepts*, and *modules*. Do any changes result? Sketch the table and its boundaries, such as the starting zone. How might different kit *components* or mechanisms fit?

Thought Processes: Systematic Variation

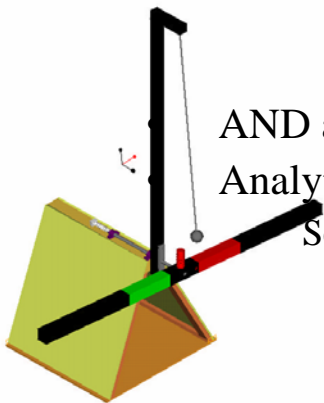
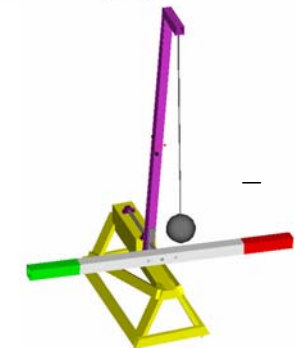
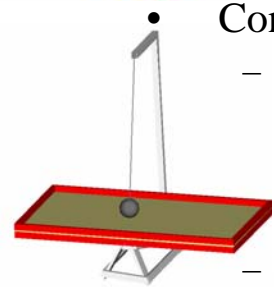

Consider all possibilities:

- Energy: How can it be applied, generated, stored?
 - Mechanical: springs, flywheels...
 - Hydraulic: piston, bladder, reservoir, propeller...
 - Electrical: line source, battery, capacitor, magnet, optical...
- Material:
 - State: solid, liquid, gas
 - Behavior: rigid, elastic, plastic, viscous...
 - Form: bar, sheet, powder...
- Motions:
 - Type: fixed, linear, rotary
 - Nature: uniform, non-uniform, transient
 - Direction & Magnitude
- Controls:
 - Passive
 - Active

AND all combinations of the above!

Analytical models of systems are invaluable

Sensitivity studies can be easily conducted

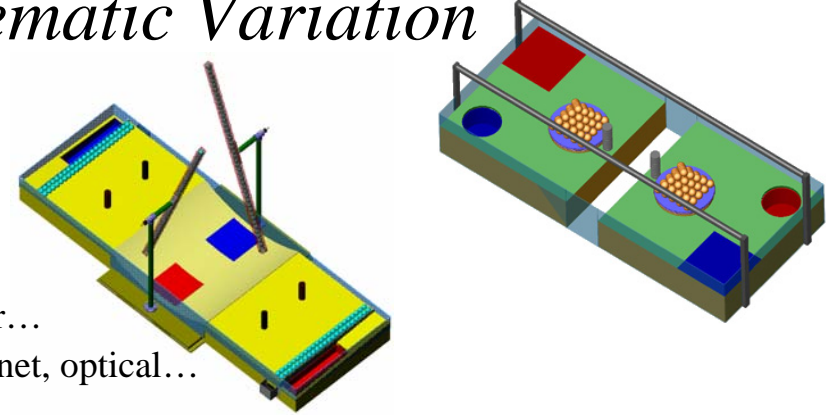

Schwinger → no machine-machine interaction

The playing field consists of two opposing swing sets. The game begins with two robots at rest in their respective swings. Robots are not allowed to push off or otherwise interact with anything but the cables and seat of their swing. After sixty seconds, the winner is the robot who has swung the greatest cumulative distance, as measured by an optical encoder. To generate a little instability in the system (and keep the crowds happy), place the swing sets close enough so that there is some overlap in the arcs.

PHYSICS & like it, but what could we use besides a fan?

I Love this very much & original

what about the other robot's swing?

good idea!

rigid, not cable to encode could read → or instrument itself

maybe add some means of getting yourself to swing?

high potentials for fun

mem. students very good at chopping stuff, not as good at protection

let them interact with this way

Egg Drop Soup

The game begins with one dozen fresh AA grade eggs in a bowl at one end of the playing field. Two robots compete to gather the eggs, and deliver them to their own marked bowls without damage.

That's such a waste of food. Couldn't we use bad eggs?

hmm

Water balloons filled with sand? this could be a serious mess! This could be a mess by the third round unless we booted eggs

SOME INTERESTING PLAYING FIELDS

BASIC GATHERING CHALLENGE

Thought Processes: *Reversal*

Reversal is a powerful catalyst for turning problems into opportunities! Consider the geometric proof shown on the opposite page. This proof is considered a high school geometry honors problem, and it is indicative of a typical mechanical design scenario, where you know what you want to accomplish, but are not sure of how the details should look. Let us first look at the geometry proof using the method of *Forward Steps* and ask relevant systematic variation questions:

- *Who* questions are not really relevant here
- *What* questions lead us to ask "what is the definition of a perpendicular bisector?"
- *Why* questions are not really relevant here
- *Where* questions are not really relevant here
- *How* can we change this problem and make it better?, by drawing additional lines on the figure to see if it makes more sense.
 - Connect all possible points by lines and see if this helps to make the problem or possible solution path clearer
- Can we use the definition of a perpendicular bisector to solve the problem using Backwards Steps?
 - In an isosceles triangle, the bisector of the base is also the perpendicular bisector
 - This is a simple thing to prove in case you do not remember its also a theorem

A *Forward Steps* solution is not immediately apparent, and so lets reverse our method and apply the method of *Backwards Steps*. It jumps out at us that if we start our proof by proving $\triangle AFB$ is isosceles, then the problem is simple. As you follow the proof in Table 1, see how some of the triangles have to be rotated in 3D space in order for their congruence to make sense! This is the fun part of mechanical design (and mathematics), you can do mental aerials that would put any snowboarder's jumps to shame!

Sometimes the best way to successfully get a date is to imagine yourself already with that person getting big air off your favorite jump, or playing that game of chess, or better yet, making stuff together in the shop! Look at the proof on the following page, which is literally written backwards. Rewrite it

(or read it) from bottom to top. It does not make nearly as much sense! So it is with many problems and their solutions!

Table 1: Backwards Proof

Step	Statement	Reason	Comment
1	$FE \perp AB$	$A=B, A+B=180$	QED
2	$\angle AEF = \angle BEF$	Equal Parts of Equal Triangles (EPET)	First prove perpendicularity
3	$\triangle AEF \cong \triangle BEF$	Side-Side-Side (SSS)	Next, state givens and then prove $AF = FB$
4	$AE = EB$	Given	
5	$FE = FE$	Identity	
6	$AF = FB$	Equal Parts of Equal Triangles (EPET)	Start with the assumption and work backwards
7	$\triangle ADF \cong \triangle BCF$	Side-Angle-Side	Before listing the statement, look at the figure, in which two sides are equal; thus show that
8	$AD = BC$	Given	
9	$DF = FC$	Given	
10	$\angle ADF = \angle BCF$	EPET	Start with the solution, and find the triangles that can show it
11	$\triangle ADC \cong \triangle ABC$	SSS	These are the only other triangles, and look, their sides are all the same lengths (colors)
12	$DC = DC$	Identity	
13	$AC = DB$	Given	
14	$AD = BC$	Given	Repeated above

Go back to your favorite *strategies* and *concepts* and imagine them competing with other solutions you thought of. What *modules* do you wish you had? What *strategies* do you think you could have used to defend yourself from yourself (you are your own best worst opponent!).

Thought Processes: *Reversal*

- When an element has a risk, a countermeasure is often the inverse of the element
 - When a naysayer in a design review points out a weakness (risk) bring them onto your side by saying “that’s a good observation, lets make sure we consider 1/weakness”
- Being able to rapidly switch between the methods of *Forward Steps* and *Backward Steps* is an invaluable skill
 - Example: Given length equalities indicated by the colored pointy end cylinders, prove that the yellow cylinder is the perpendicular bisector of the purple and red cylinders?
 - Never be afraid to add your own sketching to a problem that is given you
 - The thin red and blue lines and vertex labels were added!
 - If you do not rapidly see how to move forward, try going backwards!

As given:

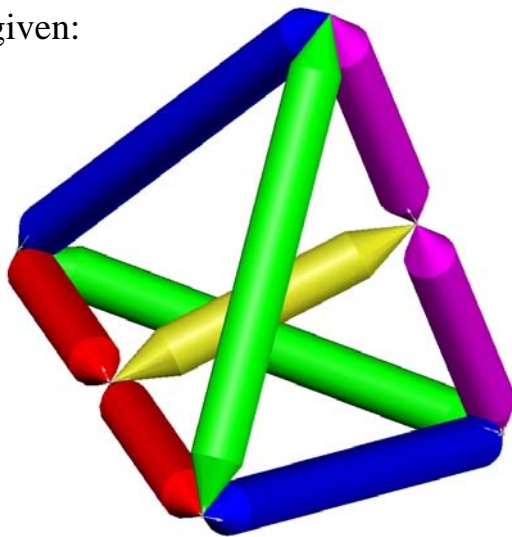

After user inflicted
clarifying features:

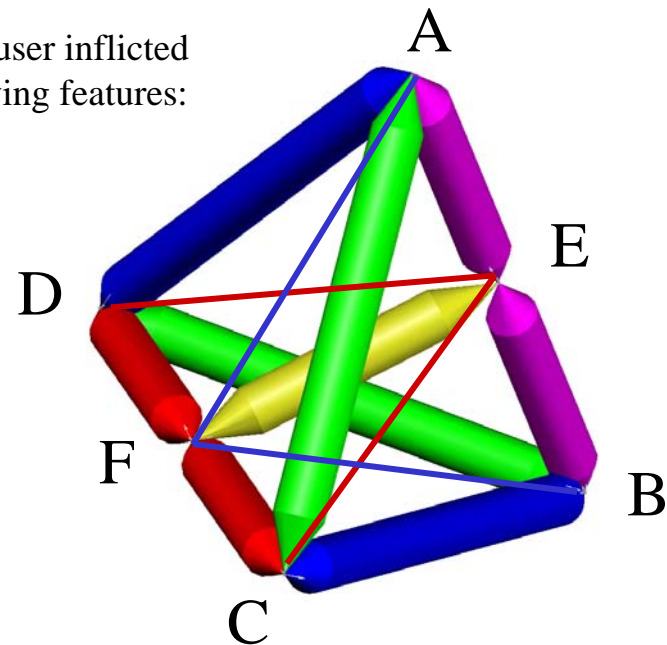

Experimentation

Experimentation is the very essence of human nature, from playing with things when you have no clue as to what they are or how they work, to systematic investigation of phenomenon via designed experiments. There are four types of experimentation on which we want to focus: *Playing With Parts*, *Sketch Models*, *Bench Level Experiments*, and *Bench Level Prototypes*. All should be created using the scientific method, except maybe for playing with parts which in the context of the scientific method is used to help form hypotheses. From the time we are born, to the time we cease to physically exist, we experiment. Therefore when we cease to experiment, we cease to exist! The only prime directive to experimentation is do nothing that results in irreparable harm (even though you might not inhale, you might still get mouth cancer!). Experimentation is a way of life, a creativity catalyst, and it is fun!

Experimentation is not only a means to help you understand a problem and possibly identify strategies, but is also a powerful tool for helping to identify risky ideas to develop. Playing with the problem and potential solution elements often creates "gee whiz, oh wow, if only I could" pictures in your mind. You would like to develop the idea, because it has a chance of putting you on the leading edge, or maybe even being a disruptive technology, but you can't seem to write the equations for optimizing the idea (or vice versa!). Accordingly, you run experiments because:

- You have never done something like this before.
- You cannot write down the equations to accurately model the design.
- You are unsure what is the best way to actually do this thing...
- If what you propose does not work, your machine is totally useless:
 - You want to identify risky ideas for early development.
- You want to run mock competitions between ideas.

Shown on the opposite page is Prof. Martin Culpepper when he was a little Ph.D. student experimenting with an engine. Marty had also experimented with kinematic couplings which enable one object to be repeatedly located with respect to another object through the use of three balls and three grooves which define 6 unique contact points¹. Marty was given the problem of how to make an engine block and its bedplate come back to the same relative position after the two are assembled and bored for the crankshaft. The tra-

ditional method uses 10 dowel pins and results in a repeatability of about 5 microns bore concentricity error. Marty knew kinematic couplings could be an order-of-magnitude better, but that they leave a gap between the objects which is not acceptable for engines. Marty also knew that kinematic couplings are designed to last for thousands of cycles, so both the balls and the vees must be very strong and not suffer from plastic deformation. Marty also knew about flexural kinematic couplings, where the balls are mounted on spring flexures that allow the coupling to occur, the springs flex, and then the two surfaces to come together and formed a tight seal.

Marty started experimenting with kinematic couplings and springs and when he calculated the stresses in vees if they were machined into the aluminum block, he found that just the weight of the bedplate caused plastic deformation. Rather than fight it, he asked what if he let the balls indent the surface as much as they wanted, and used the indentation and elastic spring-back that accompanies metal deformation to his advantage? Then the coupling could locate, be deformed by clamping bolts, the crank bore could be completed, and then when the clamping bolts are removed, the bedplate would pop up ready for installation of the bearings and crankshaft. When the bedplate was brought back to the engine, the elastic spring back gap would couple the bedplate to the block and the bolts could be tightened to close the gap.

However, it was not allowed to machine vee grooves into the block because the engine manufacturing line could not be changed, and the only way allowed to form the vees was to use a rotary motion tool in a machine analogous to a drill press. This raised the question: instead of a vee, could a pure conical surface, like a countersink, be used? A *bench level experiment* revealed the answer: "no". But if a vee was one extreme and a cone was another extreme, maybe there was something in the middle? Maybe features could be cast in the engine which when machined with a countersink leave a quasi vee? The answer proved to be yes, and the results were awesome!²

[What experiments can you perform with the table or your kit parts, and what might you learn? What's your most risky idea?](#)

1. Slocum, A. H. "Design of Three-Groove Kinematic Couplings," *Precision Eng.*, Vol. 14, No. 2, April 1992, pp 67-76. More of this topic in Chapter 9.

2. M. Culpepper, A. Slocum, "Quasi-Kinematic Coupling and Method for Use in Assembling and Locating Mechanical Components and the Like", # 6,193,430, Feb. 2001

Experimentation

- Playing With Parts
- Sketch Models
- Bench Level Experiments
- Bench Level Prototypes
- Identifying Risky Ideas

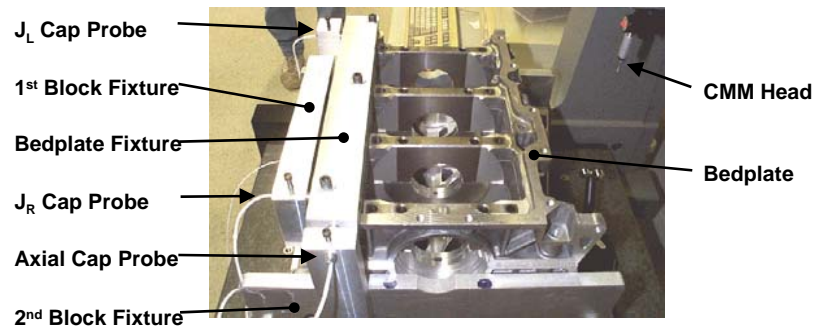
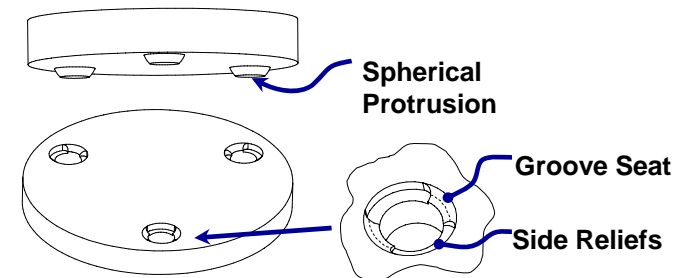
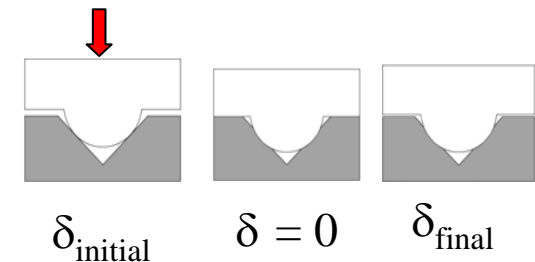
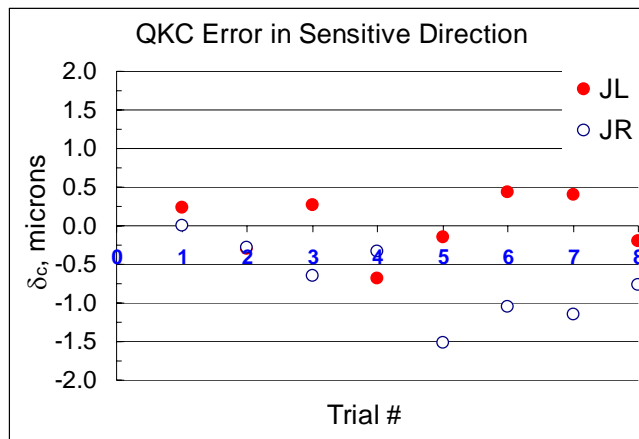
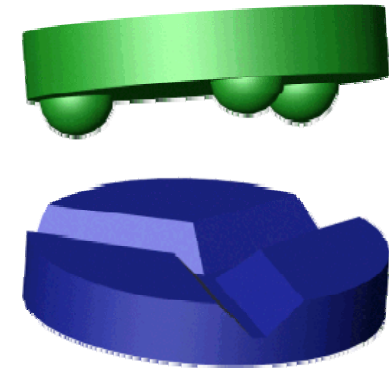
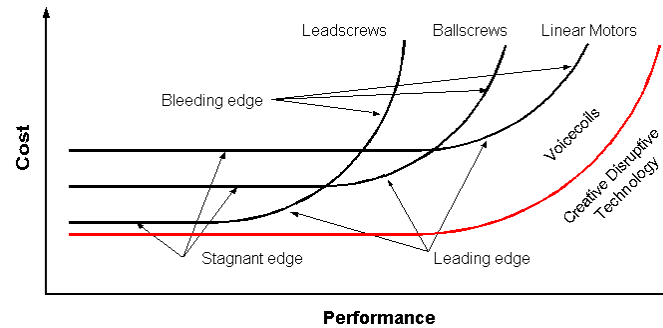

Experimentation: *Playing with Parts*

There are two forms of parts, those associated with the problem (opportunity!), and those that are available to you from which you can create a solution. There are also two forms of play which are random play and systematic play. The former is of course the wild impulsive shoot-from-the-hip see-what-this-does method that most of us have no trouble at all doing. The latter is the scientific, systematic, seek and tweak each element method that many people try to do, but then are too easily distracted. However, to make sure you do not miss anything, including creative inspiration, it is recommended that you apply both forms individually, perhaps allotting at least a day for each. Then after becoming familiar with each set of parts on its own, bring them together and see if the parameters of one can affect the parameters of the other. In fact, you can do your playing beforehand, and thus plan what you will do by thinking systematically, and then randomly while doing something useful like swimming, running, or walking.

Random play needs little introduction because it is something we have all been doing since birth. The only guidance is to make sure to first play with the problem by itself, and then with the parts available for the solution, and then with both together. An aid to help you discover new things is to listen to different forms of music. Classical music in particular is extraordinary at stimulating creative thought because it seems to literally result in the largest number of most disparate neurons firing, which seems to trigger creative ideas (seriously, this works!)

Systematic play strongly suggests that you first group the parts into their types, passive (e.g., structure) or active (e.g., moving parts, energy storage, actuators). Next apply the thought processes discussed previously to each of the elements. After the parts are identified and grouped, ask the questions: *Who? What? Why? Where? How? Can I?* Most importantly, as you are asking these questions, physically manipulate the parts.

Having gained familiarity with the parts, further analyze them with respect to *Energy, Materials, Motions, and Controls*. Again, "Who?", "What?", "Why?", "Where?", "How?", and "Can I?" are key leading questions. For example, with an electric screwdriver, that might be included in a kit of parts from which a robot is to be built for a design competition, ask questions as you examine it:

- Who supplied the motor, and can you find a data sheet and other information about it on the Internet or from the manufacturer?
- What are its physical characteristics, including size, mounting methods, and torque-speed curve? What have other people done with it before?
- Why does it sound the way it does? Why can I not turn it manually (back drive it)?
- Where can I use this? Where have other people placed their motors on their machines?
- How does it work? How can I take out the mechanical switch and wire it into my control box? How did other people use their motors before?
- Can I modify it? Can I change the input voltage from the specs? Can I back drive it? Can I make it back drivable? Can I supply it with different voltage/current than it is normally used, and what is the effect?

Next analyze the materials of the motor, again, asking the "What?", "Why?", "Where?", "How?", and "Can I?" questions. Pay particular note to the dimensions of the various components for the purpose of answering the question "can I modify it to make it easier to mount?"

Connect the motor to a power supply (or just use the battery), turn it on and carefully observe its motions, once again asking questions: What? Why? Where? How? Can I? In particular: How accurate is the motion? What effect do different loads on the output shaft have on the torque capability? Can I mount the motor in such a way that I can support the output shaft without over constraining it, so that it can handle a large radial load? What are the maximum torque and speed values and are they the same in both directions? How can I measure them to double check the values given by the manufacturer? How controllable is the motion? What happens when I cut the power, and how many revolutions does it take to stop? What is the smallest angle of rotation I can obtain?

The above is an abbreviated discussion of some of the many questions that can be asked. Go back and play some more with the table and kit parts, individually and together, to make sure you have not missed some key features or inspiring ideas.

Experimentation: *Playing with Parts*

- Lay out all the materials you have (physically or information sheets) in front of you and play with them, let them talk to you, what are their limits, how have others used them...?
 - Place components amongst each other on the contest table to obtain a physical feel for how they might work and fit.....
 - Move the table and feel its motions....
- With a “competing” partner “drive” imaginary machines with your hands to feel how things might move in competition
 - Mock competitions can help create and evolve *strategies*

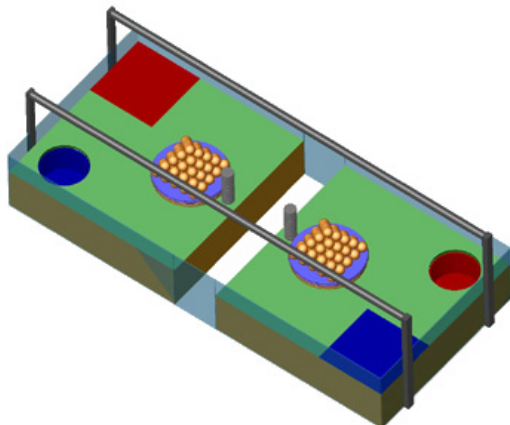

Experimentation: *Sketch Models*

A *sketch model* is a simple physical model of an idea. They are fun, because they can be made quickly, used, and discarded without any feelings of guilt such as "gee, I put so much time and effort into that, I have to use it", which would otherwise likely lead you to the bleeding edge. Sketch models are to be made rapidly using simple materials and manufacturing methods. Typically all that is need is foam core, wooden dowels, tape, glue, a knife, and maybe a sander or bandsaw. Since they are so easy to make, you should make simple sketch models to test your top two or three strategies or concepts. For example, a simple sketch model allowed for the exploration of many ideas that ultimately evolved into *The MIT and the Pendulum* contest.

Constructing sketch models quickly and effectively takes practice. Foam core, available from art supply stores, works better than cardboard, because you can cut $\frac{3}{4}$ way through foam core with a knife, and then bend it nicely with the remaining section acting like a hinge. Foam core is also reasonably isotropic, so it is less likely to buckle in a preferred plain like cardboard. Foam insulation sheets, available at building supply stores, are easily cut with a knife, saw, or a hot wire. The latter can be made by stretching a 20 gauge NiCr wire tight across a wooden frame, and then connecting the ends to the leads of a D cell battery. This allows you to cut out parts from foam and then you can assembly them. Most joints can be made with hot-melt glue or clear packing tape. Wooden dowels make excellent axles...

Once you have played with the sketch models, and modified them to reflect improvements you then thought of, you can hold a Sketch-Model-Derby to see how the ideas will compete against each other. You can rest assured that someone else has thought of many of the same ideas you have; therefore take advantage of it and use the Sketch-Model-Derby as a means to identify opportunities! In fact, sketch models are a great way to present initial *concepts* to potential customers as a means of getting their reaction, and hopefully to also provide you with constructive feedback. In the case of a robot contest, a limited number of friendly competitors can bring all their sketch models together to hold a bigger more comprehensive Sketch-Model-Derby.

While you are conducting a Sketch-Model-Derby, be sure to apply the thought process methods discussed above while imagining that your sketch model is the actual finished machine. You should also be creating a list of the

real machine's anticipated modules and their likely Functional Requirements. You can actually create draft FRDPAARC tables for each of the *modules* and use the Sketch-Model-Derby experience to help you deterministically design your machine. This is also the time to relate the anticipated *modules* back to the available *components* in your kit of materials, be they a kit for a robot contest, or the kit of the real world in an industrial project. Pay particular attention to the major systems including: *primary structural, kinematic (motion), bearing, actuator, power, and control* (including sensors and wiring) systems.

Sketch models also give insight to how you should create computer models of your *concepts*. Because they represent an actual physical experience with your idea, they provide you with insight as to what *modules* will be required, and how they might actually fit together. How a system fits together, and what is important, and what are the key physical references for its construction are referred to as the *design intent* of the system. Capturing design intent is crucial to creating a good solid model of the system. Solid models and kinematic motion simulation packages (which also check for interferences and give forces and reactions) are the mainstay of the modern design world.

Consider the use of sketch models for MIT's 2001 2.007 contest "Tilt-tilator" as shown on page 2-1. Many design contests in the past had a table and objects which the machines had to gather. To add some spice, it was thought to make the table on a pivot, and to add a pendulum! The simple foam core sketch model with a ball bearing hanging as the pendulum revealed that the system was bi-stable. What was needed was either a damper or a spring, or maybe even both. A torsion spring made the dynamics much more exciting. However, the model indicated that the table's inertia would be huge compared to the robots, and thus motion of the robots would not have as great of an effect. This gave way to the idea of just having a beam and the goal was to make the beam tilt towards your side. The next step was a *Bench Level Experiment*, which was made from Legos™ and gave exciting results. This contest able was chosen for detailing and fabrication!

Make sketch models of your top *strategies* and have a Sketch-Model-Derby. Note any discoveries, including the need for revised *strategies* or the creation of new offense or defense *concepts* and *modules*. Modify your FRD-PARRC Tables accordingly



Experimentation: *Sketch Models*

- Sketch models are made from simple materials (e.g., cardboard, foam, hot-melt-glue, tape, string) and they allow you to literally “play” with potential *strategies*
 - Later, when you have a *concept* developed, they enable you to “test drive” your machine *concept* around the table
 - In the “real world” where designs are often very complex, sketch models are still often important “proof of *concept*” aids
 - They can be invaluable sales tools!
- A *Sketch-Model-Derby* is an invaluable way to test ideas, with minimal risk of time and materials
 - See <http://me.mit.edu/lectures/sketch-modelling/2.2-examples.html>
 - Evolution of *The MIT and the Pendulum*:

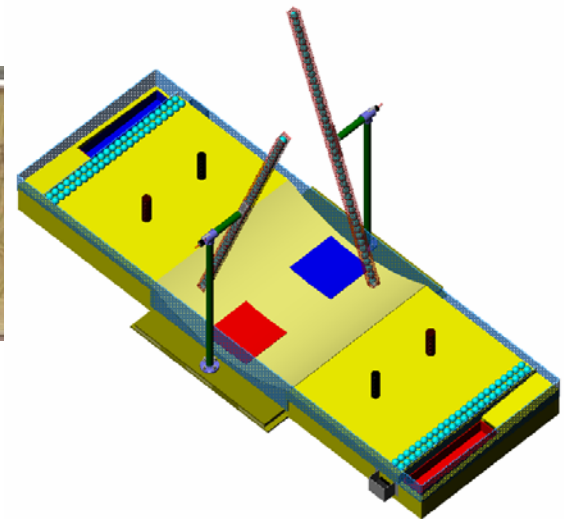
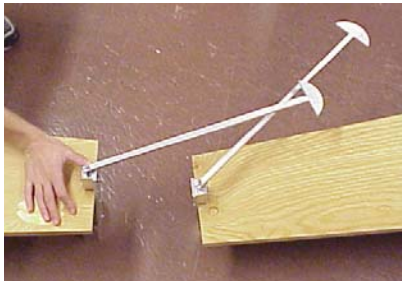

Experimenting: *Bench Level Experiments*

The mechanical design process is a very visual activity. Physically handling the hardware and moving it about the contest table rapidly loads your bio neural net. "Play" scenarios with the parts can help to visualize and test motions, but they do not give accurate representations of forces and kinematics. Sketch models help to identify areas of risk, and hence the most critical *module* to develop. A *Bench Level Experiment*, on the other hand, is an actual design experiment intended to provide real physical data regarding the expected performance of your machine. Thus, the experiments should be designed, just as you would design the actual machine, using the deterministic design process. The BLE is a microcosm of the entire design process.

A BLE can range from a simple Lego™ model of a linkage, where the link lengths are scales of the linkage you propose to use in your machine, to an experiment designed to see if a material will hold up to extraordinary conditions. A BLE can also let you test the performance or assemblability of some aspect of your machine with which you are not totally comfortable with because you have never done anything like this before.

Consider the design of a bearing system to allow telescoping members to extend in a robot design competition. You can use either bulky, low friction, load limited rolling wheels, or compact low friction large load capacity sliding contact bearings. In this application, the telescoping members are trusses made from welding rod, so the bearings have to run on round shafts that are just 3 mm in diameter. Consider a design process for the experiment:

Table 2: FRs, DPs, As for bearing experiment (what are the Rs, Rs, and Cs?!)

Functional Requirements	Design Parameters	Analysis
Determine relative effective friction forces	Spring scale pulling simple sled with 4 bearings on 2 rails made from U shaped welding rod and clamped to table.	Delrin™ physical properties, Coulomb friction, and Hertz contact stress.
Determine if Delrin will cold flow in-situ	Start with FLAT Delrin™ blocks, then test grooved blocks and wheels	The Delrin™ should cold flow to form a groove on the wheel as it turns.

The most sensitive parameter which has the highest risk is the contact stress; thus calculations are needed to estimate it. To calculate the *Hertz Con-*

tact Stress, which is discussed in detail in Chapter 9, the critical parameters are the relative radii of curvature between the elements in contact. A wheel of diameter D (25 mm) has its radii of curvatures $D/2$ and infinity across its width. Welding rod of diameter d has its radii of curvatures $d/2$ and infinity. The analysis clearly shows the flat wheels will yield against the rails:

Rod: Ronemaj (m)	1.00E+06	Poisson's ratio ν_{one}	0.29
Rod: Ronemin (m)	0.0015	Poisson's ratio ν_{two}	0.29
Wheel: Rtwomaj (m)	1.00E+00	Equivalent modulus E_e (Pa)	2.94E+09
Wheel: Rtwomin (m)	-0.0017	Equivalent radius R_e (Pa)	0.0162
Applied load F (N)	150	Ellipse c (m)	5.27E-03
Phi (degrees)	0	Ellipse d (m)	3.87E-04
Max allowable contact stress (Pa)	2.76E+07	Contact pressure (Pa)	3.51E+07
Elastic modulus E_{one} (Pa)	1.04E+11	Stress ratio (must be less than 1)	1.27
Elastic modulus E_{two} (Pa)	2.76E+09	Deflection (μ units)	18

What about using flat Delrin™ blocks? In the same spreadsheet the major (diametrical) and minor (crown) radii of curvature of the "wheel" are made to be 1m and 1m respectively, which yields a stress ratio of 3.7, so it will yield and continue to do so which will result in rapid wear. When the wheel is given a curvature of $-1.1*d/2$ (negative indicates conformal), the stress ratio is still too high at 3.9. When the flat pad is given a groove, the contact pressure can be dropped to whatever we want, because then the contact pressure is just the length of the sliding bearing element divided by the rod diameter. To make the stress ratio $1/2$, the sliding bearing element should be 7 mm long.

It was decided to still run the experiment, because the wear rate should be low enough for a few cycles in the robot competition. One goal of the experiment was also to shed light on the fact that the rolling wheel friction includes the sliding friction between axle and wheel, and the wheel non-roundness caused by high contact stresses. The force to push Mike (150 lbs) was about 15 pounds, and wheel indentation did occur, but no obvious severe wear was observed. The force to push Mike (150 lbs) on the sliders was about 20 pounds, and the indentation on the 30 mm long sliders was small. Best of all, Mike (riding) and Dave (pushing) both survived!

Identify your most risky, yet potentially rewarding, *module*, and design BLEs to help you develop or discard it!

Experimenting: *Bench Level Experiments*

- Experiments to test function, force, friction, and speed, are a vital part of the design process
 - Analysis is potentially the quickest way to verify an idea
 - Remember, to be thorough! The first 4 letters of *analysis* are...
 - Analysis inexperience or uncertainty can lead to *analysis paralysis*
 - Analysis paralysis is most often relieved by a simple experiment

Example:

- Idea: Use a winch to pull the pendulum back and forth?

- Experiment: Tape a motor to the beam and tie a string around the pendulum and see if the motor shaft can wind the string up and pull the pendulum over

Does the motor's distance from the pendulum affect how far over it can pull the pendulum?

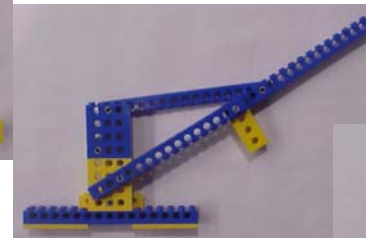
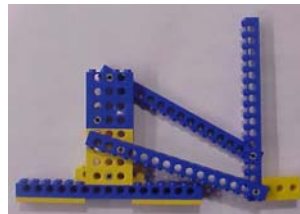
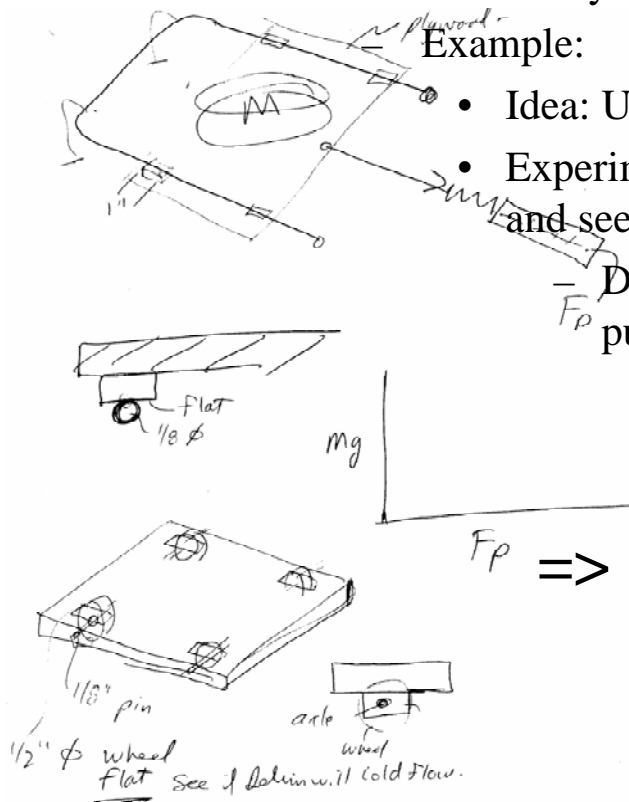

Experimenting: *Bench Level Prototypes*

Page 2-1 showed a sequence of sketch, solid model, BLE, solid model, and what seems like the final contest table (with the winners!) for the 2001 MIT contest *Tiltulator*. The BLE showed that the pendulum made the table essentially bistable and that was no fun. Thus a torsional spring was added. Here is a clear case where after the idea first evolved, it was apparent that an analytical model of this two-pendulum system would be more difficult than making a sketch model. Instinct told the designers that this might be like an inverted pendulum and hence not be very stable; thus a solid model was made to help visualize the idea and to generate proportions. Then a BLE was made and it showed the system was indeed bistable, where it flipped between the table being all the way to one side or the other depending on the amplitude and phase of the pendulum swing. The addition of a simple rubber-band essentially reversed gravity and brought the system back into the realm of a double pendulum chaotic stability! We were now ready for a *Bench Level Prototype* of the system! But how strong should the spring be? What should be the inertia of the beam? What should be the mass and length of the pendulum? Would this really work? A FRDPARRC table was created to guide the design:

Table 3: FRs, DPs, As for the *Tiltulator* Contest

Functional Requirements	Design Parameters	Analysis
System inertia on the order of robot inertia	Thin-wall aluminum tubing	Inertia and tube strength
Pendulum period and mass on the order of robot performance	Light-weight mast	Spreadsheet to estimate period and inertias
Safety	Long system time constant relative to human reaction time, safety tape, padding	Make a BLP and test

What would the *References*, *Risks*, and *Countermeasures* be? The pendulum was first envisioned to be a shot-put, but the potential for someone to get hit by the swinging steel ball was not pretty, so a heavy soft thing was needed. The need for a countermeasure catalyzed visions of a water-filled tether-ball appeared in the professor's mental attic of stuff. Accordingly, a spreadsheet was made to estimate system inertias, and from this the overall system dimensions were selected:

Pendulum	
Length (m)	2
Period (seconds) ($\sqrt{L/g}$)	0.45
Mass (kg) (water in a tether ball)	2.8
Crossbeam (square tube)	
Length (m)	2.5
Cross section (m)	0.102
Wall thickness (m)	0.003
Density (kg/m^3) (aluminum)	2500
Inertia ($\text{kg}\cdot\text{m}^2$) ($ML^2/12$)	4.1
Mast (same section as crossbeam)	
Length (m)	2
Top cantilever length (m)	0.4
Inertia ($\text{kg}\cdot\text{m}^2$) ($M_{\text{top}}L^2 + M_{\text{mast}}L^2/3$)	9.6
Robot	
Maximum mass (kg)	5
Inertia at end of beam ($\text{Kg}\cdot\text{m}^2$) ($M(L_{\text{crossbeam}}/2)^2$)	7.8

The mast inertia seemed a little high, but in the interest of using a single cross-section size, and the fact that the system without the robot was balanced, made the team decide to move forward. A torsion spring was designed so that when the robot was all the way to the end of the beam, the beam would deflect halfway to the ground. A *Bench Level Prototype* (BLP) was then built and tested successfully. The variables left open to tuning were the torsional spring constant (spring shaft diameter) and the amount of water in the tether ball. The overall BLP worked so well that it actually became part of the final working contest table, with only small modifications being required.

Think ahead and envision what your *strategy's* risky *modules* might be. What appropriate analysis or BLEs might be required before you can select a best *strategy* and *concept*? Will this allow you to use a telescope and create a BLP early-on in the design process and get ahead of schedule? Avoid doing too much detailed work too early on, but beware everything looks good on paper; hence *Mens at Manus!*

Experimenting: *Bench Level Prototypes*

- Once you get to the *concept* phase, you may have a risky idea, which if it works, would be awesome
 - A *Bench Level Experiment* was performed to prove the principle of an idea, but it is not a potentially functional part of the machine
- A *Bench Level Prototype* is designed to ideally be an actual *module* to test a risky *concept*
 - Design it well, and if it works, it could be a ready-to-use *module* for your machine!
 - It often shows what works and what must be fixed in a *module* (like the software!)
 - A robot contest BLP would be to create a vehicle to test its speed and controllability
 - Use modular *components*, so you can change them to optimize performance
 - E.g., change the gear ratio on a vehicle's drive train



Oops! Software crashed it again!

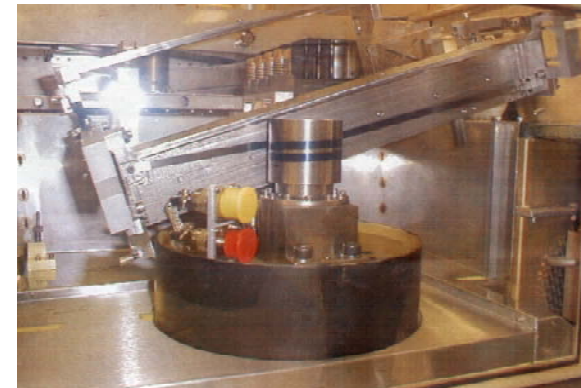

Programmers are not that innocent!

Drawings

Drawings, from sketches to 3D CAD models are means by which we can create snapshots of our thoughts, and thus communicate our ideas to others, as well as help us ponder our own ideas. Sometimes we can see things in our heads, but we just cannot make the fingers move the pencil properly. In days past, such deficiencies would drive us away from design; however, the advent of 3D CAD systems and parametric solid modeling frees us from the constraint of having to be able to draw like Leonardo DaVinci. Nevertheless, drawing, by hand and by computer, are universal means of communication, and thus are skills that need to be developed to the best of your ability. This does not mean creating perfect width lines, but rather creating drawings with deep content that convey clever design intent.

There are three phases of drawing in the design process: motion and force diagrams, sketches, and solid models. Motion and Force diagrams help you to understand the physics of the environment. This first phase in the drawing process is merely a graphical interpretation of Newton's laws: The 2nd Law states that the resultant force (torque) acting on a body is proportional to its mass (inertia) and its acceleration. The 3rd law states that for every action there is an equal and opposite reaction. Hence intended motion and forces go hand in hand and on the same sketch. Accordingly, understanding the motions and forces in a problem can direct where your mechanism will have to act.

Once you understand the motions and forces within the system, e.g., the contest table, you can begin to get a feel for how different *strategies* can be used to manipulate these motions and forces. Although you can start to envision a machine that might accomplish the task, resist the urge and just create a motion and force diagram for the *strategy* about which you are thinking. Then, once you have an idea about the motions and forces that your strategy will have to accommodate, you can start to sketch the *strategy* in terms of a stick figure. As the design process advances and the idea becomes more detailed, so do the sketches. Sketches are generally hand-drawn, but they can also be simple line drawings made on a CAD system, or even very simple solid models.

Sketching is a great way to think out of the box (sometimes literally!). It is a low risk activity that does not require major effort, and it seems to help promote the free flow of ideas. The downside is that everything looks like it will work in a sketch. Consider the figure on the opposite page with the nine

dots. Cross through each dot by drawing four straight lines without your marking device ever being lifted, and without backtracking. Such topology games are invaluable brain exercisers, so when traveling, waiting in lines... take along a book of topology teasers with which to play! Did you get the solution? Start in the upper left corner at (1,1) and draw a line down to virtual dot (4,1), and then up to virtual dot (1,4), over to dot (1,1) and then down to dot (3,3). Who said you have to stay within the confines of the original real dots?

Once the feasibility of an idea seems to be established with a sketch, it may be appropriate to create a very basic solid model that captures the overall geometry of the idea and thus illustrates the basic design parameters that satisfy the functional requirements of the problem (opportunity!). As the idea develops further, you can add more detail to the model, or delete unnecessary features, IF the model was constructed in a robust manner (more on that later). Solid models can be useful at every step in the design process, as long as the appropriate level of detail is maintained.

Because solid models came into being after drafting programs, where making changes was difficult, some people are loath to pick up a mouse and create a solid model because they feel it too early locks them into a design. However, parametric solid modeling tools make it so easy to create geometry, that the overhead in time is minimal. In fact, a simple solid model can act as a sketch, and be far more accurate and truly representational than a hand sketch. Thus often a sketch needs to be a little more than the motion and force diagram before you pick up the mouse and start solid modeling.

Take stock of your drawing skills: Were you able to solve the little nine dot problem? No? Then you really should be playing more puzzle games like this and focus on having no bounds. Can you close your eyes and visualize the contest table and now open them and sketch it on a blank piece of paper? No? Then you need to practice learning to internally visualize things, so every time you see something of interest, practice painting a mental picture of it, and then try to recall it in detail as you start to fall asleep at night. Are you able to look at a complex object from different perspectives and then visualize it in 3D in your head? No? Then you can develop this skill by looking at objects in silhouette and then sketching the simple 2D projections from top, front, and side views, and then using these views as guides, try to draw an isometric (3D) view of the object.

Drawings

- Motion & Force Diagrams
- Sketches & Mock Battles
- Solid Models

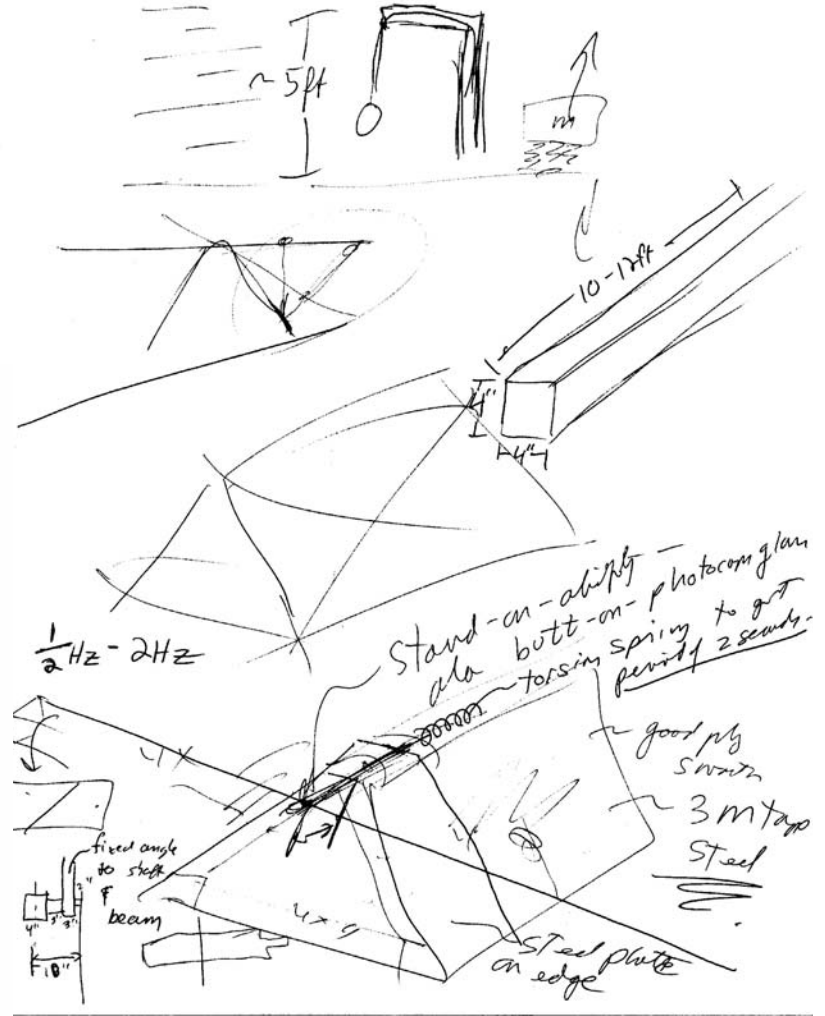
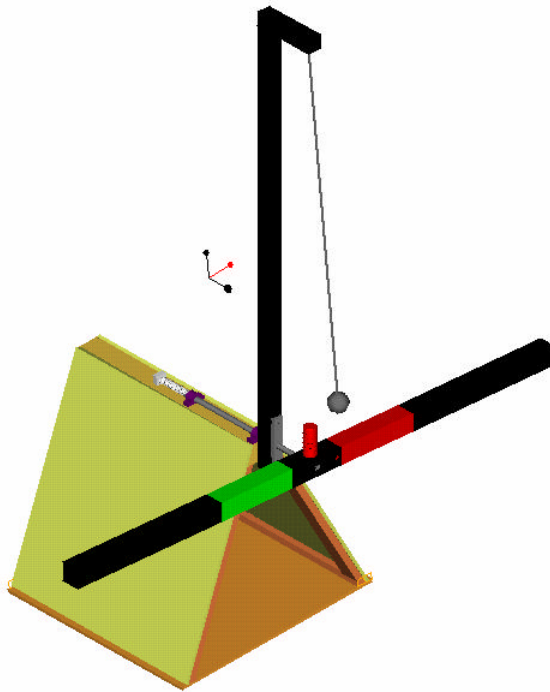
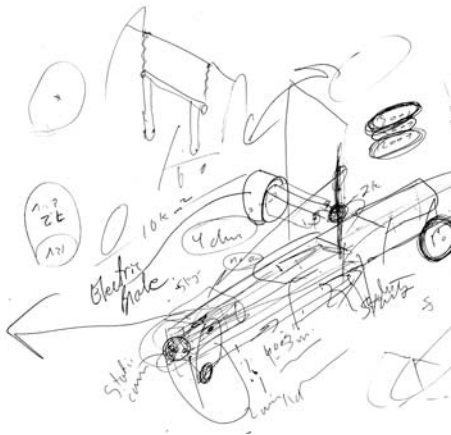
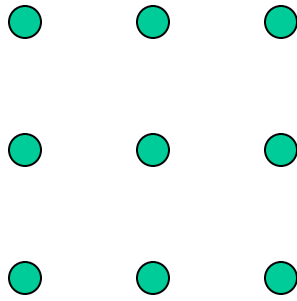

Drawing: Motion & Force Diagrams

Motion diagrams are often the first step in developing a **strategy** to solve a problem (discover an opportunity!). The system on which the machine operates is first sketched in its initial and final states, and arrows are drawn on it to indicate what moved where. Next illustrate possible motions with lines, arcs, arrows, and let the motion diagram speak to you. Arrows, lines and arcs can then be drawn in different colors to help envision the motions that the mechanism would need to do in order to make the desired motions to occur.

A key aspect of a *Motion & Force Diagram* is that it allows you to step back from the environment in which the machine is to operate, and then “poke it” from all angles. Bear in mind that there are only *TWO* fundamental types of motion that can occur in a machine: linear and rotary. If you approach the environment from every single angle and push it in every possible way, you will generate many different possible **strategies**. By combining them in different manners, you will likely create a few overall awesome winning **strategies**. Generating motion and force diagrams is one of the single greatest creative catalysts in the design process.

Your motion drawings should whisper to you what sort of analysis might be appropriate so you can create an analytical model to explore feasibility & effectiveness of the idea and its possible variations. It should tell you to explore a scaled, evolved, or revolutionary alternative of something that perhaps exists somewhere. It may call you to sketch this idea on the same drawing in a different color. Your motion diagram should scream out ideas for **concepts!** You should be breathing heavy! As a result, you should be able to complete a first-order analyses of each of your potential **strategies**, and this will then indicate which ones are worth carrying forward to be investigated at the next level of detail.

For the robot design contest *The MIT and the Pendulum*, a simple motion and force diagram triggered a lot of forehead-slapping creative thinking which then was organized with a FRDPARRC table. Note that this table is by no means an exhaustive study of all the possible ways to score, but it highlights a comparison between two fairly obvious **strategies**: climbing the pendu-

lum and imparting enough velocity to it so it swings high enough to dump the balls inside, while leaving the vehicle free to score by other means.

Table 4: FRs, DPs, & As for *The MIT & the Pendulum Robot*

Functional Requirements	Design Parameters	Analysis
Dump balls from pendulum	1) Climb up and use axle to torque. Use springiness of tube to maintain wheel preload. 2) Impact pendulum while driving, collecting, and dumping.	1) Primary: speed robot can climb based on motor power. Secondary Preload, friction coefficient, wheel size, contact stress, motor torque to climb, tube stiffness. 2) Vehicle KE vs. pendulum PE
Get pendulum moving	1) Engage axle with drive wheel. 2) Hit it periodically	1) Engagement force needed to maintain drive torque. Motor torque to get tube spinning. 2) Timing
Score with objects on ground	1) Bulldozer 2) Flinger	1) Size and speed. 2) Projectile motion

Table 5: Rs, Rs & Cs for MIT & the Pendulum Robot

References	Risks	Countermeasures
1) There must be some robot for climbing poles? Traction drive systems. 2) Bulldozers have been done before	1) Wheel contact force too high, not enough tractive effort, speed too low. 2) Enough velocity?	1) Projectile grappling hook and winch assist. Grab tube near edges so do not damage. Spring preload wheels. 2) Multiple hits
1) Traction drive systems, screen-door wedge-locks. 2) Bulldozers have been done before	1) Drive wheel-to-preload force will be hard to maintain 2) Timing	1) Reach-around-and-grab-and-preload-from-behind module 2) Fast paddle wheel or springy flapper
1) Many previous contests. Construction company websites. 2) Flingers or shooters been done before.	1) Maneuverability, can blade push balls into scoring area? Opponent blocks? 2) Aiming, complexity	1) KISS and practise driving. 4WD or crawler treads (risky!) 2) Pick simpler idea.

Go ahead and create *Motion & Force Diagrams* to help you generate and create **concepts** for your **strategy**. Have you drawn arrows representing ALL possible types of motion that can occur on the table? How might these motions be caused to occur? How does the potential for angular versus linear motion in your machine affect your sketches?

Drawing: *Motion & Force Diagrams*

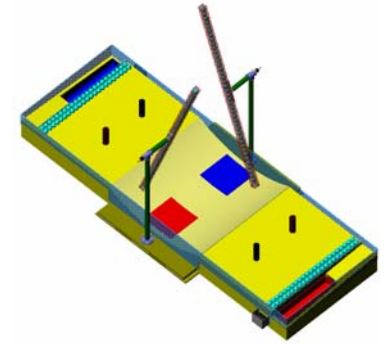

- It is important to sketch the idea of a *strategy* without including any mechanical detail:
 - Just use arrows to indicate directions of motions
 - Illustrating the motion with mechanism implies a concept
 - Use different colors!
 - You do not want to start implying specific *concepts* because this could lead you to spend time developing it before you explore enough *strategies*
 - Time is precious
 - For an illustrative reference, read *If You Give a Mouse a Cookie*
 - **Use your motion and force diagrams to help create a preliminary power budget!** (see page 7-26 and *Power_budget_estimate.xls*)

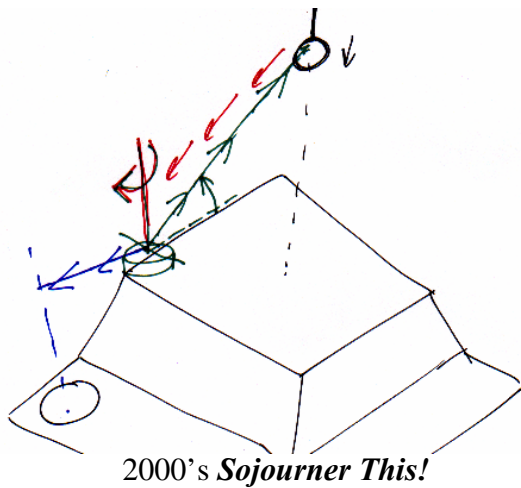

2000's *Sojourner This!*

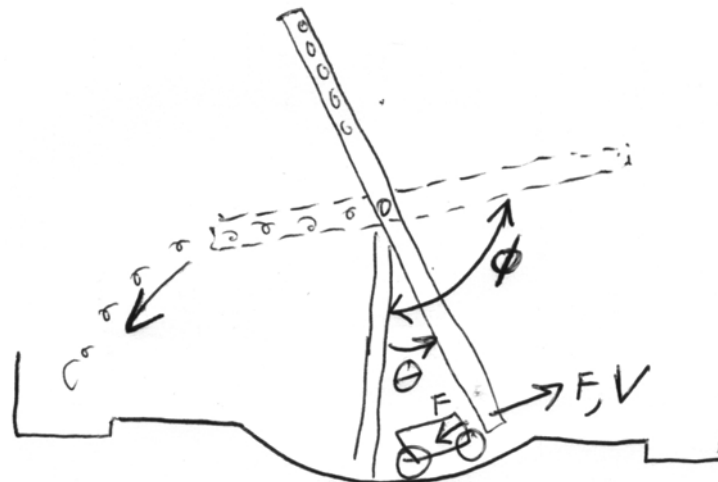

2002's *The MIT and the Pendulum*

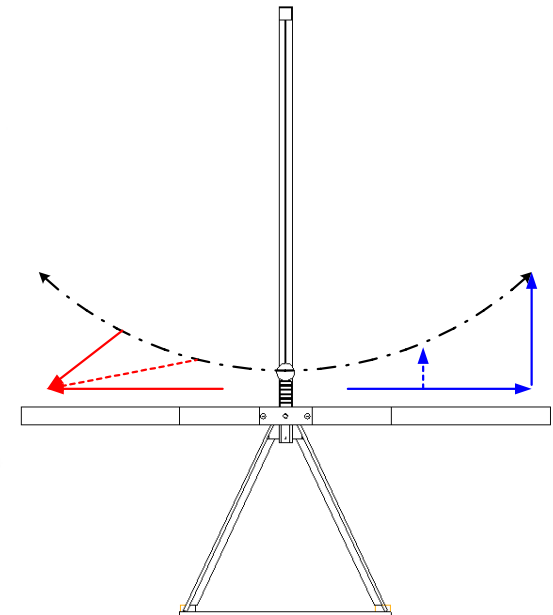

2001's *Tiltulator!*

Drawing: Sketches

Part of the *art* of design is knowing how much detail to put into a drawing or *sketch* in order to convey enough information so another person can understand your design intent. A *sketch* is thus defined as a visual representation of an idea with just enough detail included as is appropriate for the corresponding phase of the design. The first sketches in the design process are thus motion and force diagrams with enough information to allow others to understand your basic *strategy*. These diagrams would typically be sketched by hand on a solid model of the environment (e.g., the contest table). Along with a FRDPARRC table, they allow an independent reviewer to evaluate your idea, such as might be done during the *Rohrbach* process described on page 2-23.

To illustrate a mechanism that could implement the *strategy, concept* sketches should be created. These might show a linkage, but would probably not show the joint detail between the links, unless it was deemed a risky element of the design. *Concept* sketches are also first done by hand, and should be accompanied by appropriate analysis, as discussed on page 2-18, to make sure that the physics of the *concept* is viable. Once the physics is deemed viable, then along with a FRDPARRC table, the *concept* sketches should allow an independent reviewer to evaluate your idea. Once the Rohrbach and brainstorming processes are complete, the top candidate *concepts* should be solid modeled to create the overall geometry. This would also likely require an additional level of analysis to be completed to preliminarily size major members, so appropriate space can be allotted to them in the solid model. Details such as fillets and bolt patterns should not be included in an early sketch unless they are critical features of a design.

The *concept* sketch should start off being created by hand, because this is your first effort to visually describe the design intent of your idea. The design intent is the embodiment of the dominant physics or geometry of the idea, and it thus acts as a roadmap to guide the development of the rest of the idea. For example, in Chapter 1, the *Axtrusion* design was discussed on page 1-14, where the design intent was to use orthogonal planes as the primary precision features, and all other aspects of the axis design keyed off of them.

With *appropriate analysis*, which may be as simple as calculation of basic geometry, the first-order solid model sketch of the concept can be created. This solid model only contains the basic features that capture the primary

design intent. An important function of a *concept's* solid model is to identify the primary *modules* that will have to be developed in detail. After design reviews and *mock competitions*, a final *concept* can be chosen, its first order solid model modified accordingly, and then the detailed engineering can begin. However, in general, even during the detail phase, motion diagrams and quick hand sketches are created in the designer's notebook to capture the *design intent* before the solid model is created.

Once you have created sketches of your ideas, such that others can also understand them, it is a good idea before you go any further to pit your ideas against each other in *mock competitions*. Often the difference between ideas is small, or your first choice idea is selected based on your knowledge of manufacturing processes. However, your 2nd and 3rd choice ideas could very well be someone else's 1st choice design, and thus you need to design to compete against yourself. Mock competitions should first be conducted while you are still developing *strategies*. You can at first do them by yourself, but since one can generally convince oneself of the brilliance of one's idea when one is by oneself, it is a good idea to get together with trusted associates to engage in a mock competition, or have a *Sketch-Model-Derby!*

In a mock competition, each person sketches their favorite *strategies* (arrows of motion, or simple stick figure) on a blackboard or sheets of paper and then pretend that the different *strategies* are competing. The participants then role play as their *strategies* and see how they interact, noting strengths and weaknesses. This same type of process can be completed when you have generated *concepts*. The *concepts* can be played off against each other, and weaknesses can be overcome by the development of new operating *strategies*, or perhaps the creation of a new offensive or defensive *module*.

Describing your ideas in front of a group does wonders to discover hidden pitfalls AND potentials! Whenever a weak point is discovered, try to overcome it by design, or use it to your advantage. In the end, everyone will benefit, and since any contest depends so much on implementation and driving skills, you should have little fear that your secret idea will escape and be widely copied. Get together with friends in the class and have a mock competition! Use the results to develop/evolve your idea including adding offensive or defensive *modules*. Update your FRDPAARC Tables accordingly.

Drawing: *Sketches*

- **Strategies** are sketched with simple arrows to indicate motions
- **Concepts** are sketched showing overall design intent via possible mechanisms and blocks representing modules
- **Modules** are sketched showing basic types of components
- **Subassemblies** and **components** capture detail and design intent
- Pit your sketches against each other in mock competitions!
- Good sketches and a not so good sketch:
 - Try to sketch in 3D!

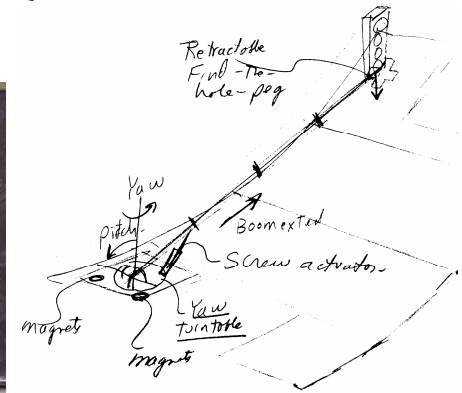
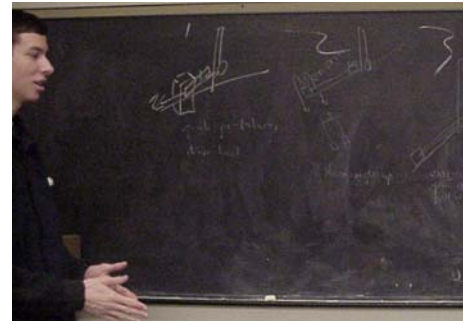
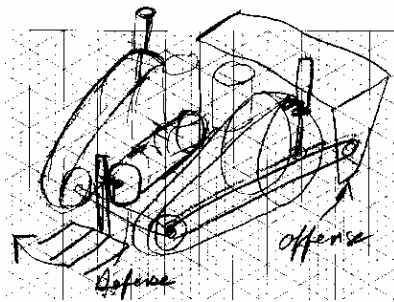
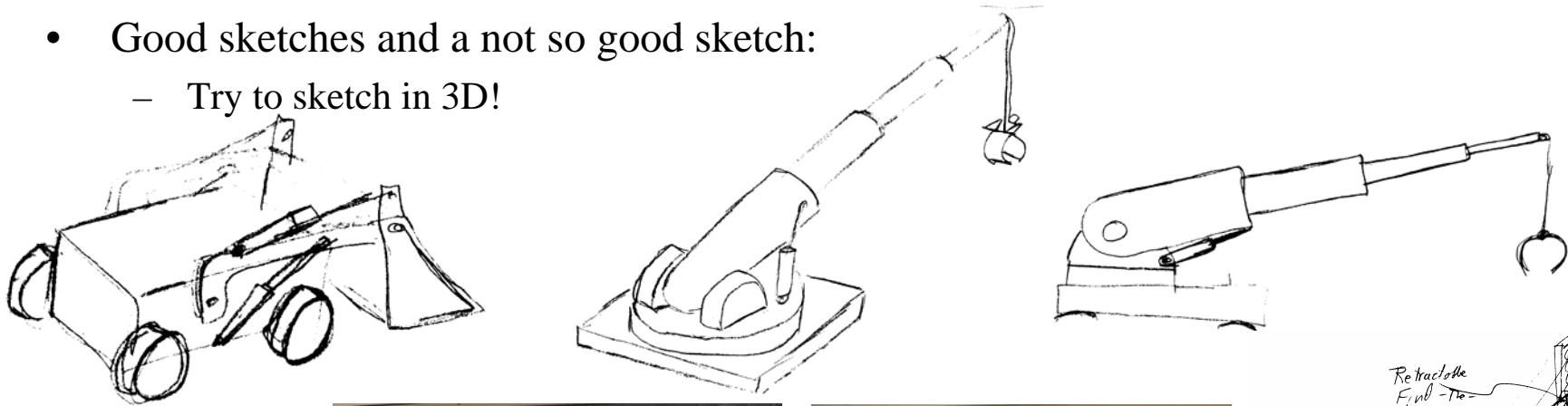
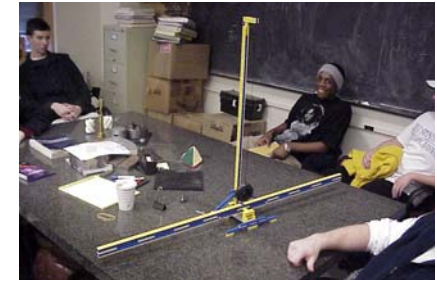

Drawing: *Solid Models*

Solid models are powerful design aides, but like any powerful tool, they can be dangerous if misused. Constructing a robust solid model is the best way to ensure flexibility, and hence usefulness of the model; however, it requires thinking ahead as to what you want to do. This generally takes little more than a few quick sketches to capture the overall *design intent* of the idea. Then you can create individual parts, subassemblies, and full assemblies.

There are several types of solid modeling bad practises, ranging from *fine* to **Coarse**. The first most obvious problem occurs when designers create a complex part with many features representing different future parts, just to get an idea into the computer. They keep on adding features even though they know it will later have to be broken up into separate parts. They feel too rushed to take the time to make individual parts and bring them together in an assembly.

Likewise, when creating parts, a bad habit is to put too many feature geometries into a single sketch prior performing a solid operation (extrude, cut) with it. For example, sketching a section composed of 37 segments and then forming a solid from this one complex section. It is generally better to create a series of simple shapes that are then used together to form the complex section. This not only reduces the risk of system crashing and data loss, it also makes it easier to change the model by deleting one of the sections.

When creating a part with many features, if the features are dimensioned or referenced to anything other than primary features or reference datums, then there is a chance that the model will become unstable should you delete one of the features. This is the classic parent-child feature relationship problem. If the parent, say a protrusion, is deleted, then the child, say a hole that passes through the protrusion into the main body, may become an orphan, and the model will become unstable. Different programs handle this situation differently from the annoy-me-now message that the model will not regenerate, to the annoy-me-even-more-later messages that occur when you have built up many more features which crash when nonexistent references are attempted to be referenced. Fortunately all these programs offer tools, some easier than others to use, to fix these parent-child problems. However, the best way to address these problems is to avoid them in the first place. All you have to do is think ahead and reference the features back to datums (planes or curves).

Similarly, great care must be taken when specifying dimensions. Ideally dimensions should be specified with respect to datum planes, or features that will never be deleted; otherwise a design change that calls for a feature to be removed may end up causing the model to crash when a dependent (child) can no longer find its parent feature. One of the most important and overlooked aspects of solid modeling is the awareness that the dimensions that are put in the model are the same dimensions that automatically are used when the part drawings are generated. Thus since a primary use of the model is to generate manufacturing drawings with as little pain as possible, do not create more work for yourself by randomly assigning dimensions. THINK ahead to the creation of part drawings and drawing standards when dimensioning solids' features.

A similar problem occurs with assemblies. If the model is built like a real robust system designed for manufacture, interfaces between modules are made on a high level, so freedom is given to modify a module's design without affecting the entire assembly. Thus in order to make assemblies more robust, assemble them from modules that are joined at basic fundamental features that are very unlikely to have to be deleted. The key once again is to reference assembled *components* or *sub-assemblies* or *modules* as much as possible to reference datums and as little as possible to detailed features.

Most solid model packages offer more than just a 3D look at the geometry of the system; they also offer analysis functions such as computing the mass or section moment of inertia properties. Some also enable you to partially constrain objects in an assembly so with your mouse you can apply virtual forces and study the kinematics of motion, of say a linkage. Most solid modeling systems offer an interface to finite element programs for more advanced analysis, or an interface to linkage design programs. For advanced design practice, the solid model can be linked to tolerance analysis programs such as CETOL, TI Tol, and VSA. Solid modeling packages will one day automatically do tolerance analysis and error budgets.

Create a robust simple solid model of the contest table. Create solid models of a few very simple *concept* ideas and make sure you know how to place them on the model of the table to make sure they fit, and to "play them". The solid model of a *concept* can also be used for virtual play on the contest table.

Drawing: *Solid Models*

- Creating a solid model of the environment (e.g., Contest table!) helps you build a solid model of your machine, to make sure it will fit!
 - A solid model of the environment lets you make measurements outside of the lab, to make sure your mechanism will fit
- A solid model of a *concept* starts with simple parametric shapes, that will essentially define volumes into which *modules* must fit
 - Detail is added as the design progresses
 - Use *Tools/Equations* to add relations between dimensions
 - When you change a primary dimensions, all other dimensions related by equations automatically change too!
 - The design "morphs" automatically
 - The true power of solid modeling: You do not have to track down and change umpteen different dimensions in different parts!
- Analysis of a solid model can serve as a *Bench Level Experiment*, to illuminate problems and help guide sensitivity studies

Alex Sprunt's machine

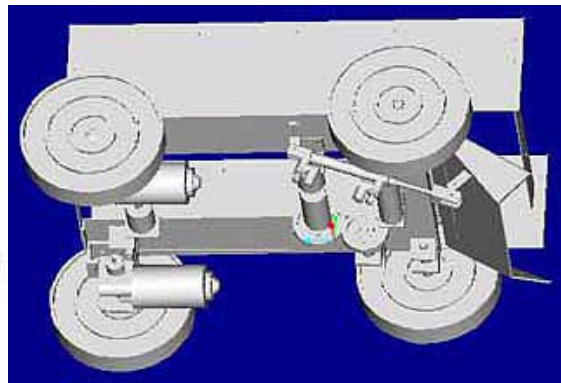
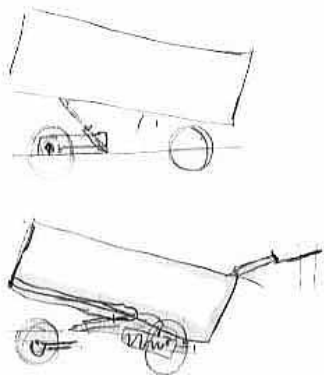
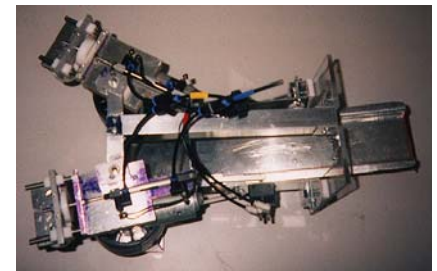
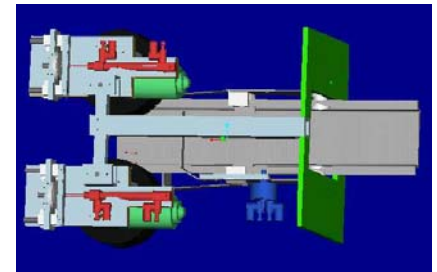
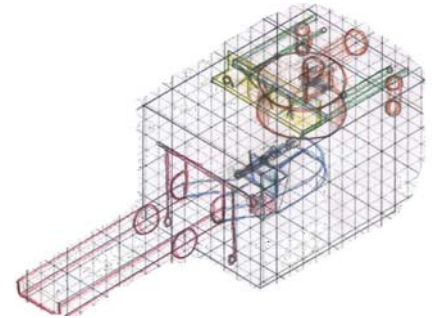

2-14

Felix Lam's machine

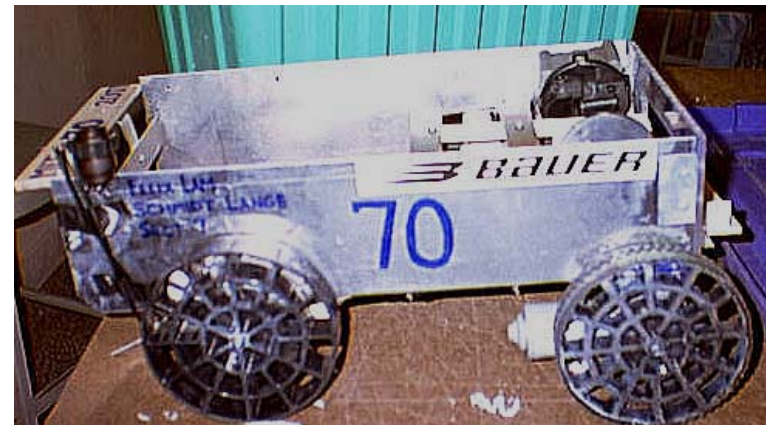

Research¹

The ability to research and extract abstract thoughts and then use them to create exciting designs is an invaluable ability, especially since there is so much knowledge embedded in our history². Perhaps the biggest problem designers have is that when we have such a great idea, it's just not possible that anyone else has thought of it, so we merrily detail away until someone else points out it has been done better before. Remember, most designs are scaled or evolved versions of what has been done before, and there is no shame in that. Hence it is vital to conduct good literature searches in technical libraries and also search the web for similar products which may exist, and might not have been documented in archival journals. When reading about machines:

- Carefully study the failure modes of machines: Robust design, where the machine repeatably does what is expected, is critical!
- Carefully study the success modes of other machines
- Controls and operator skills are often critical

Reading about past projects can be invaluable. From books to websites, such as <http://pergatory.mit.edu/2.007>, and also <http://precision.me.gatech.edu/class/me2110/>, there is no shortage of information on just about everything, especially robot design competitions! To see what's been done and what works, carefully study all the far corners of the web pages, as goodies are often hidden. By looking at past contests and machines you can discover new **strategies** and gain insight into what works and what does not.

You may require a basic knowledge of how things work, so check out www.howthingswork.com. Do you want help with detailed component design? *Stock Drive Products'* on-line tech library has many answers which can be seen at http://www.sdp-si.com/Sdptech_lib.htm. Do you need help with analysis? Check out <http://www.efunda.com/home.cfm>. Do you want to design a construction-equipment-like vehicle? Go to construction equipment manufacturers' websites! Search and you will find, click and it will open

To find technical or scholarly literature on your topic, you'll want to search an article database. Think of this as a search engine that only searches for articles, conference papers, or book chapters on a particular subject. The actual articles aren't found in these databases, but you will find citations to the articles. Then you can check in your local library to see if they have subscriptions to the journals (maybe even online) or own the books you need. For engineering, you should search the article database *Compendex*. For electronics, computation, control, robotics or physics, search INSPEC. In some cases you'll be able to search both of these databases at once. These are just two examples though. Just ask your friendly librarian for help!

Once you've done a literature search, it might be a good idea to set up alerts. An alert is a program that saves your search parameters, so every time the article database is updated, if an article falls within your search parameters, you'll be notified by email. Which means you won't need to remember to periodically search the database to stay up to date on your topic!

Now that you have citations for articles, it would be a good idea to organize them or put them all in one place. There is software (bibliographic management software) that can help make this easier for you. Ask your librarian about products such as RefWorks (www.refworks.com) or EndNote (www.endnote.com). This type of software will not only help you organize your citations, but help you insert citations into your paper (or poster or whatever you are working on).

There are many different web search engines: Try different ones, and different terms. It can be frustrating, because searching for anything can turn up nothing or everything: try strategic combinations of key technical terms. Try looking at the search engine help screens for tips on searching. For example, if you want to search rechargeable lithium ion battery as a phrase, do you put it in quotes or parenthesis or leave it as is?

Think of your favorite **strategies** and **concepts**, and go to the web and find some construction machines or other types of machines that may use similar ideas. What can you learn from them? Search for traction enhancing methods, is there anything relevant? Is there anything from a past contest that might indicate what might be useful for traction enhancement?

1. Extra special thanks to Angie Locknar, a most excellent librarian at MIT who helped write this section!

2. Westheimer's Discovery: A couple of months in the laboratory can frequently save a couple of hours in the library.



www.bobcat.com

Research

Go to your local museum of science, as they likely have a neat mechanisms room!

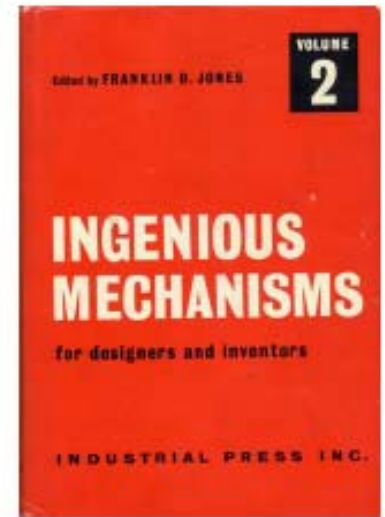

- Books, journals, trade magazines...
- Past events
 - Show guides, competitor catalogs
 - Previous contests!
- The Internet
 - Popular search engines
 - Engineering and scientific databases!
 - University technical library

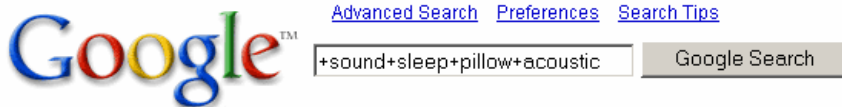
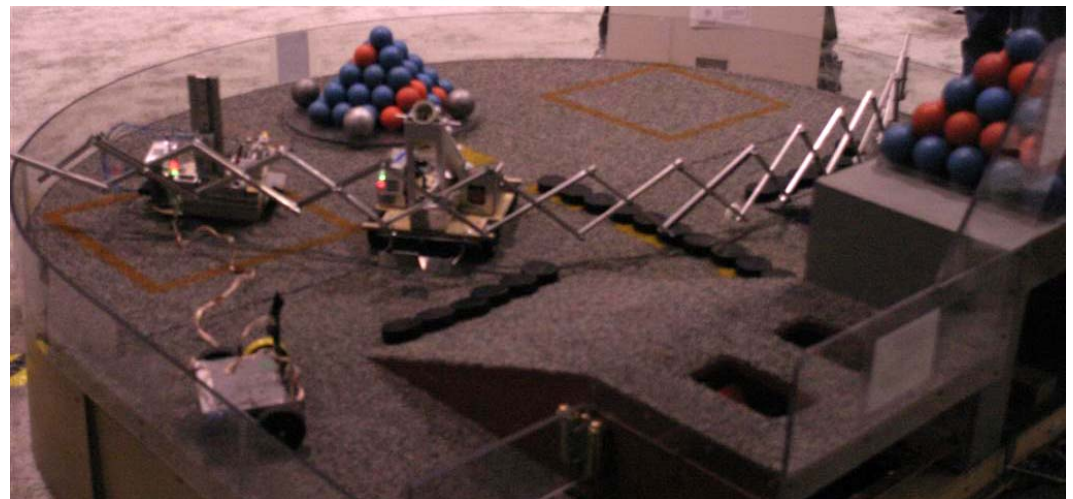

Searched the web for **+sound+sleep+pillow+acoustic**. Results 1 - 1

[Sound Spa Deluxe Acoustic Relaxation Machine with LCD Alarm ...](#)

Patents & Standards¹

The patent system was created to encourage people to make knowledge public of how to do creative things. In return, the government grants the patent holder a monopoly on the idea for 20 years from the date of filing. An amazing array of machines have been patented, and designers should tap into this knowledge base. However, only 1% of patented ideas ever make it to market because of serendipity or stoopidity, so caveat emptor! The US Patent office maintains a searchable website that also provides information on how to file patents: www.uspto.gov. All patents can be viewed online, if you know the patent number, and are searchable from at least 1976-present. Try other free patent web pages like freepatentsonline.com for pdf copies of patents granted after 1976. The USPTO web page also includes a list of libraries that receive copies of all US patents. Academic libraries often have web pages for help searching patents, like libraries.mit.edu/patents.

If you find an idea you want to use, make sure to check out to whom the patent has been assigned. For older patents, the inventor might have tired of paying the maintenance fees, and let the patent expire. An example is the novel design by Vincent Berkley who was granted US patent 4,637,738. The author came up with this great idea to use sine errors, as discussed in detail on page 4-9, to compensate for bearing rail parallelism errors. "Hmmm" he thought, "I had better do a patent and literature search, as this seems like it must have been done before". The idea was found with a patent search, using the terms "angular", "deflection", "parallelism", and "misalignment". The patent had only 2 years before it was set to expire. An enquiry to the patent office revealed the patent had been abandoned, and POOF, a new royalty-free machine was born. But, searching in the same class of patents revealed another similar more recent patent... What would you now do?

Some companies do not want their engineers to search patent databases for ideas for fear that they may get an idea from a patent that is still active. However, if an engineer creates a new product and the company brings it to market only to find that the idea infringes a patent, an even worse situation will exist. It is probably better to obtain ideas from expired patents, and be aware of current patents that you must design around. In many situations, a

reasonable license can be obtained, so just because a patent exists for an idea, do not think that there is no hope!.

When you work in a team, you should also be aware that each an every inventor on a patent must be associated with some claim in the patent. Just because a person works on a product for which a patent is then filed does not mean that the person gets their name on the patent. If a patent is issued and it can later be shown that one of the listed inventors had nothing to do with the invention, the patent can even be declared invalid. Hence it is important for each person to keep a good design notebook.

There are many patents for cranes and extending mechanisms and construction equipment as well as many clever linkages. Many patents have expired so feel free to use them. A valid patent, if not expired, prohibits anyone from making, using, or selling a device which infringes the patent. To infringe, each and every element of at least one claim must be present in the infringing device. Just because your machine looks like it has a part that is the same as a figure in a patent does not mean it infringes. Read the claims!

But wait! There's more! When designing, you may want to take a look at standards which often evolve from expired patents for really good ideas. Ever wonder why all lamps and light bulbs are designed to fit together? Or why all street signs are the same height? Designers, engineers, electricians, or almost anyone creating a product follows a set of standards for their particular specialty. Standards may ensure safety, reliability, interchangeability, or other aspects of a product, process or system. Standards are approved by organizations such as the American Society for Testing and Materials or the American National Standards Institute. To search for standards, you can use free search engines such as NSSN. Academic engineering libraries, like the Barker Engineering Library at MIT, often have a collection of print standards for students to view and use. Libraries may have a help page for searching standards (just like patents!), for example libraries.mit.edu/standards.

Cruise www.uspto.gov and see what kinds of mechanisms you can find that relate to your concepts. Read some of the claims to see if you might be infringing. If you do, can you use an idea for your contest machine even though you are just a student using it for a simple contest? Can you write to the inventor and ask for permission to use the patent just this once?

1. Extra special thanks to Angie Locknar, a most excellent librarian at MIT who also helped write this section!

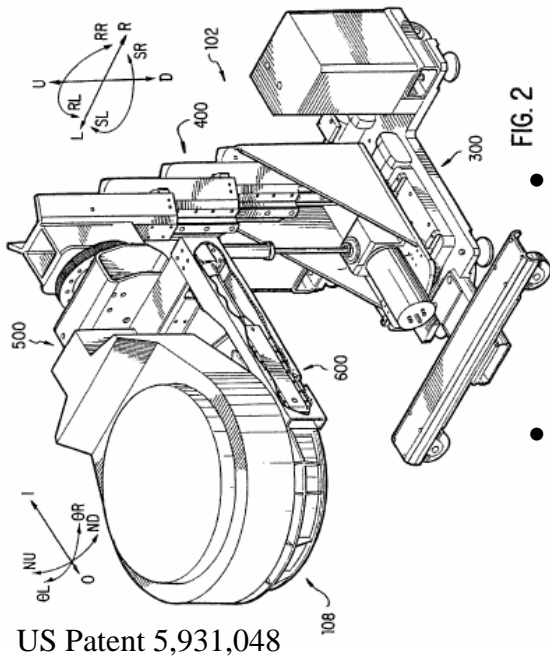
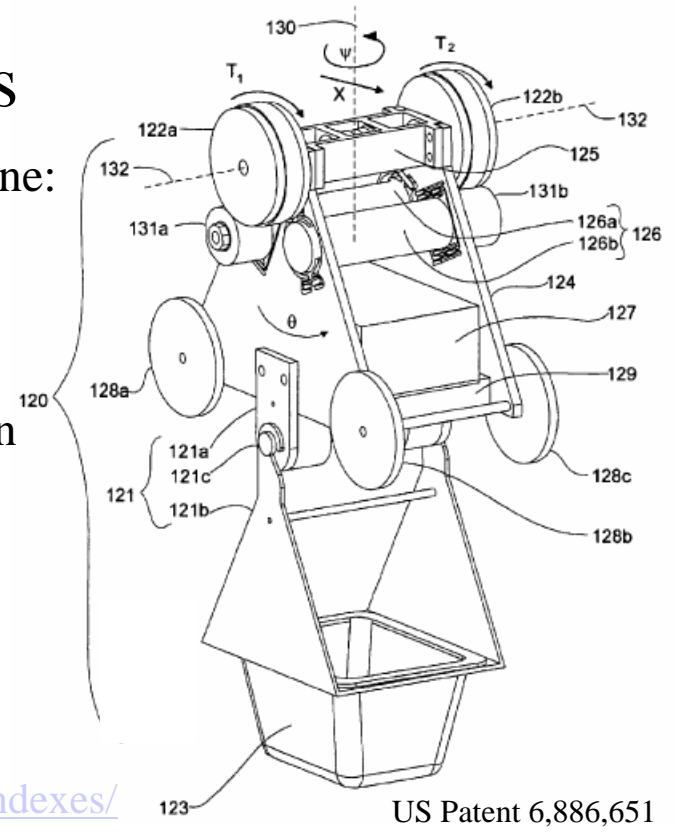

FIG. 2

US Patent 5,931,048

Patents & Standards

- Patent searches can be done online:
 - Library databases
 - www.uspto.gov
 - www.freepatentsonline.com
- Standards contain information on “how to do things right”!
 - www.nssn.org
 - www.ansi.org
 - www.astm.org
 - www.iso.org
 - <http://www.normas.com/DIN/indexes/>



US Patent 6,886,651

Publication Types

Patents at MIT

Where to Search

- Utility and design patents
- Biotechnology and chemistry patents
- Aggregate analysis of patents

How to Search

- Search strategy
- Guides for searching



US patent 5,176,454

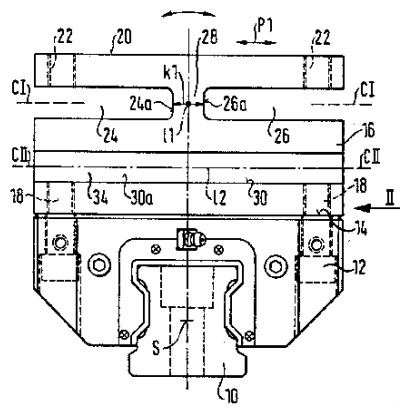

2-16

BRITISH STANDARD

Specification for motors for battery operated vehicles

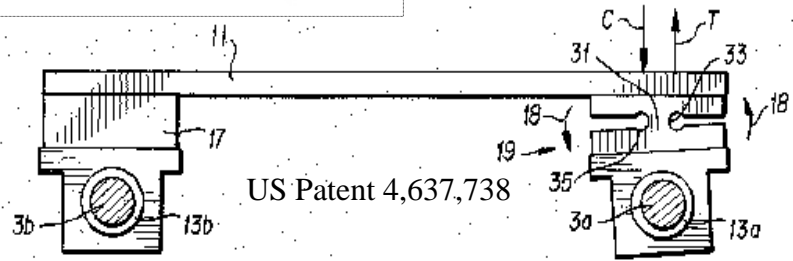

US Patent 4,637,738

FIG. 3

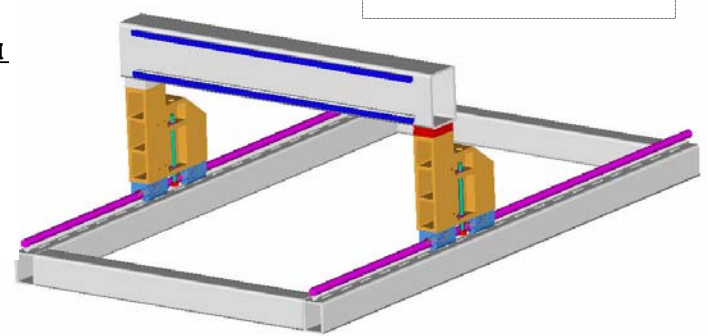

Writing

People who think in terms of pictures ∇↑↓▶◀↶↷ sketching a lot¹. People who think analytically in terms of equations σηουλδ βε ωριτ ινγ εθυατιονσ α λοτ.² People who think in words should be writing vivid stories to describe their ultimate design contest. In fact, *all people* should do *all three!* In fact, writing not just your thoughts, but also lists of possible resources, can be a phenomenally powerful creativity catalyst. Writing includes creative fantasies about how you see the contest, and creating lists and tables in the manner of systematic variation as a design process tool. BUT beware endless flaming. For rapid communication of ideas, bulleted lists and tables, such as the FRDPARRC Table, are often the most efficient means! Can the creative writing process be used to describe the motion of the pendulum as it arcs upward, and discover graceful motions of an ideal *strategy* and *concept*?

As I grip my control box with sweaty hands, I wait for the signal to start the contest. As time comes to a standstill, and the roar of the crowd fades in my head, the contest starts and I react. My machine races forward towards the pendulum. It yields to my machine and it arcs gracefully up whilst being pushed by my surging mechanism. The pendulum rises past the point of no return and its load of balls streams out towards the goal. My machine reverses and engages the pendulum for another thrust, building even greater speed as I race to gather objects and bin them. The pendulum attains such speed that it spins like a propeller and my score climbs ever higher. Together, pendulum and machine have become one, as they score past the point of no return...

You can even create a poem or song to cheer your machine onward! As you write it, you can envision your machine's creation and operation, and just maybe, discover the need for a new module, or see a new driving strategy. Its all part of living the design in your mind, of playing the movie in your head, of seeing yourself do that thing you never thought you would get to do! Give it a try: Take the deterministic path and write down all the possible energy sources and mechanisms and materials. Systematically vary all possibilities, and see what new ideas materialize. Take the creative path and write a short story or poem to describe how your strategies will work!

1. should be
2. should be writing equations a lot

It's Time By Marc Graham

It took, several weeks to reach the peak,
but now that the designs are tweaked, the actions speak
for themselves, parts off the shelves were limited,
dig into the box, start the model then finish it,
design takes time, so I start mine early,
can not be afraid to get my hands dirty,
know requirements, develop modes to fulfill the needs,
smaller wheels for power and the bigger wheels for more speed,
avoid being greedy, see objectives let them lead the process,
building the machine that is best to win the contest,
competition makes the best of me, I love the challenge,
time management in stages represented by the balance,
of other activities, A to Z,
concentrating on the deadline, looking out for Murphy,
signs point to the goal, total control,
from the time that they say go, until the final blow,
show what I'm made of, and what I made,
will amaze those who spectate, for many days,
I create to become greater, it is my fate,
to make what ever poses challenge, to my mental state,
and I can't wait until I'm labeled number one,
of my competitors, when it's all said and done.

It's time, to design, It's time, to design...

The wait is over, the final minutes are diminishing,
round number 12 and I'm waiting for the bell to ring,
blood sweat and tears got me here where I stand,
and I hope to be the last man, giving all I can,
everybody wants to be a winner, so everybody tries,
though only one will get the prize, we all rise,
if we learn to use the tools we were given to produce,
making old things new and the gray skies blue,
here's a clue, me to you, those who never did, never knew,
so when it is your turn to do, stick to it like glue,
from the cock-a-doodle-doo, till the man in the moon,
says it's safe to assume the wait will be over soon,
I empty out my bucket daily, then refill it,
and if it isn't made already, then I will build it,
no mountain is too high, nor any road is too long,
if it doesn't break my spirit, it will only make me stronger,
I congratulate all that have created, may your work be appreciated,
hold you head up high because you made it.

It's time, to design, It's time, to design...

Writing

- Putting it in your own words....
- Lists and Tables
- Narratives
- Poems, raps, ballads...

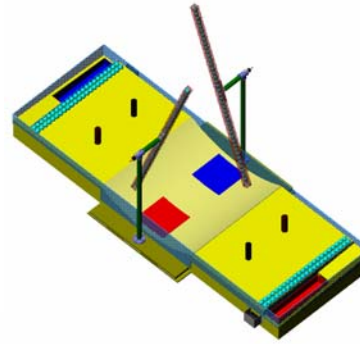

PROJECT STATUS UPDATE: NOFER TRUNIONS

Work has been proceeding in order to bring to perfection the crudely conceived idea of a machine that will consistently refragigate Nofer Trunions. The current design concept, known as a Turbo Encabulator, supplies inverse reactive current to unilateral phase detractors and thus is capable of automatically synchronizing its internal Cardinal Grammeters.

The original machine has a base plate of pre-fabulated amulite surmounted by a malleable logarithmic casing in such a way that the two sperving bearings are co-linear with the pentrametric fan. The main winding is of the normal Lotus-O-Delta type, placed into pateodermic semi-blode slots in the stator with every seventh conductor being connected by a non-reversible tremic pipe to the differential girdle spring at the upper end of the grammeter. 41 (yes, 41!) manestically spaced grouting brushes are arranged to feed into the rotor slip stream a mixture of high S value phenolbitatol benzene and 5% ruminative tetra tyliodol hexamine. Both these liquids have a specific pericosity given by:

$$P = 2.5 Cn 6.5$$

where n is the diethetical retribute of temperature phase disposition, and C is Colomondole's annual grilliage constant. Initially, n was measured with the aid of a metapolar diffractive pilfrommeter, but to date nothing has been found to equal the transcendental hopper dactascope.

Undoubtedly, the Turbo Encabulator has reached a high level of technical development. It has been successfully used to produce sucraactively modified Nofer Trunions in large volumes. In addition, whenever a bardensen scorn motion is required, it may be employed in conjunction with a drawn reciprocating dingle arm to reduce sinusoidal depletion in the Nofer Trunions' bifurdangled hipniscorn.

Believed to be written decades ago by a long-forgotten soul at Phi Kappa Tau fraternity, Rensselaer Polytechnic Institute

Analysis

Does your machine have the power (Watts = Joules/second = Force*velocity) to accomplish the work (Joules = Force* distance) in the allotted time (seconds = never enough)? Will your machine's wheels (your opponent should take the low μ and you should take the high μ) spin ineffectually ($F_{\text{traction}} = \text{MIN}(F_{\text{normal}}\mu, \Gamma/r_{\text{wheel}})$), thus making your high torque (N-m) motors useless? Can your machine race back and forth N times in M seconds across the table to gather elements and then deposit them in the goal? Will your linkage be limp because your actuator does not have enough force?

A very important part of analysis, and often used as a catalyst to help create appropriate formulas, is *dimensional analysis*, also referred to as the *Buckingham-Pi theorem*: The units must work out! You can often "derive the formulas" just by making the units work, which may not give the exact number (you may be off by a constant) but it will often show the trends and sensitivities. ALWAYS check the units on your calculations (e.g., stress =N/m²)

The ability to create a simple mathematical model of a system is of paramount importance, for it is with initial analysis of a problem that engineers can conduct rapid reality checks to ensure that the ideas they are thinking of could be made to work. However, the basis for failure to do appropriate initial analysis begins where design is often first taught. 90% of the complaints of "Design classes eat up ALL your time" occur because students just do not do the physics before they rush off to build! Why? Perhaps because of the misguided notion that design and analysis are different disciplines, when in fact they are very much related. Both often have to deal with unstructured problems with various inputs and desired outputs. Design is just often more visual and physical than analysis is perceived to be. However, if analysis is approached in the same way as design, writing down what you want to do (FRs), how you might do it (DPs), then you have a good chance of creating useful analytical models and solving otherwise difficult analysis problems.

Sketches or sketch models can often help you visualize the problem to be analyzed. For example, while running a Sketch-Model-Derby, create a systematic list of systems in each design, and the physical parameters that affect their performance and hence determine uncertainty. Carefully consider the primary structural systems and the loads to which they are subjected. Kinematic (motion) systems provide the motion desired. Can they support the loads to

which they are subjected? Power is required for the machine and what can the actuator systems provide? By identifying the physics, and *concept* details (Design Parameters) that start to emerge, this will allow you to determine if you can realize a design with the hardware available. From your physics book to websites, such as <http://www.efunda.com/home.cfm>, there is no shortage of references to help with the analysis of most problems.

For example, in the 1997 MIT contest *Pass The Puck*, Tim Zue noticed that many people were designing platforms on which they could start their machines so that they could race over the top of the barrier. Tim realized that everyone had the same materials and the same motors and the same weight limit, so there would be a lot of pushing stalemates, because everyone was FRICTION limited. Tim glued sand paper, which was part of the kit, onto his platform that elevated his machine to the height of the center ridge. All other opponents elevated platforms had aluminum surfaces. Thus Tim's bulldozer *system* had greater tractive capability than his opponents. Tim won in every single "pushing" contest, AND went on to win the contest.

Analysis can help you develop winning *strategies* and it can keep you from getting hurt. In the 2001 2.007 contest at MIT, Will Delhagen and Alex Jacobs determined that a pneumatic cylinder could provide far more force far faster than could a screw jack, so they took advantage of that year's trial rule for swapping materials. They traded their sheet aluminum for aluminum tube and made pneumatic pistons. Their initial calculations of stress in the wall showed that the cylinder had plenty of strength; however, in a design review with the professor, he pointed out that the thin end caps would likely be subject to yield-level stresses. The equation for a plate clamped at its edges and subject to uniform pressure showed that the rim of the plate was loaded to near yield. This was corrected with the use of a thicker plate and tie rods, much the way a commercial cylinder is manufactured. The moral of the story is: always check every element in the structural loop; and have an experienced non-biased engineer to do a safety review of all your critical components!

What type of analysis needs to be done to evaluate the *strategies* you created as a result of your *Motion and Force Diagrams*. What are the key physical parameters of the contest table? What is your design intent and what are the corresponding key physical parameters of your *strategy*? Create a first order spreadsheet or MATLAB code to investigate the sensitivity of your idea. Is your *concept* robust enough to win given a modest variability in the system?

Analysis

- Appropriate Analysis
 - *Ratiocinator emptor*
- Scoring Sensitivity
- Geometry, Time & Motion
- Energy, Momentum, & Strength



Sir Isaac Newton (1642 - 1727)

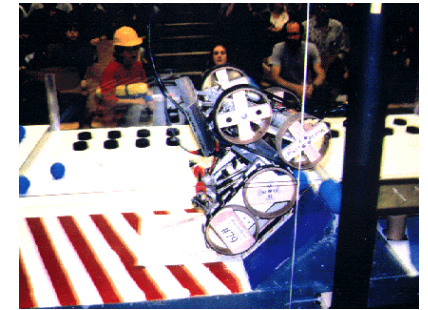
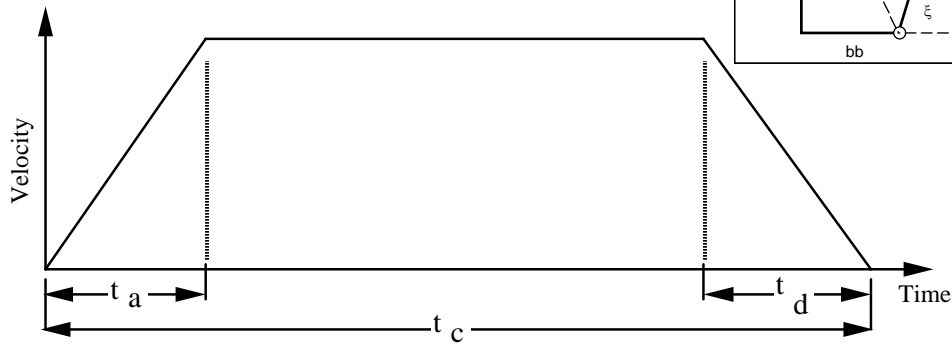
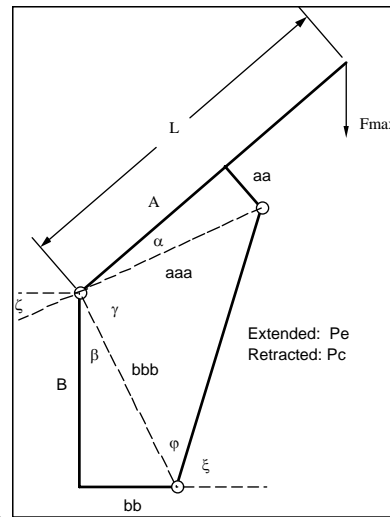
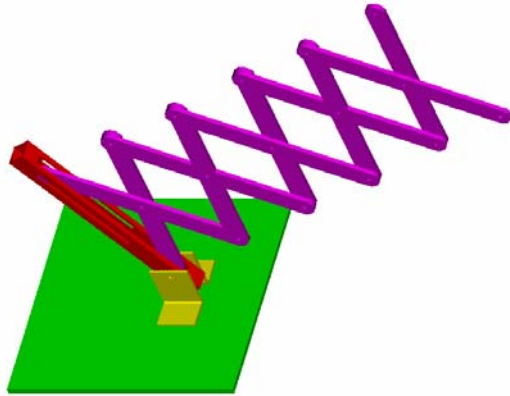

Tim Zue

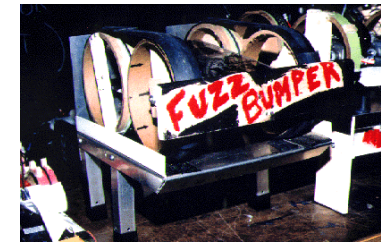

1997's *Pass The Puck!*

Will Delhagen & Alex Jacobs



2001's *Tiltulator!*

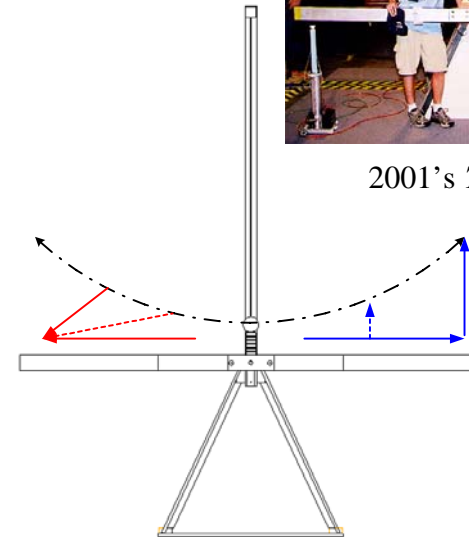

Analysis: Scoring Sensitivity

The first step in the practice of good analysis is to actually write in words what you hope to determine. Then draw a picture and label the variables. Only then should you start to worry about the equations. In the end, geometric compatibility (e.g., $a^2 + b^2 = c^2$), force/moment balance (e.g., $\Sigma F = 0$, $\Sigma M = 0$), and physical (constitutive) relationships (e.g., $\sigma = E\varepsilon$) will enable you to solve the problem! Most tasks have a value assigned to their worth and as such a mathematical model of the system can be optimized to create as much value as possible. This is also the basis for most types of financial analysis.

As an example, consider a very simple problem such as measuring the height of a building using either a long or short ladder of known length, and a ruler and a protractor. Which ladder should you use to measure the height of the building, and by what method? The answer is *I do not know, lets analyze the system*. The Functional Requirements are "Determine building height". Possible Design parameters are: "Ladder length" (known) combined with "Angle Measurement", OR "Distance Measurement". A sketch shows the geometry of the problem and the relevant parameters for the two types of trigonometric analysis. Strategy 1 is to measure the angle θ and knowing the ladder length to obtain the building height. The critical measurement is the angle, so determine the sensitivity to a change in angle

$$H_{building} = L_{ladder} \sin \theta$$

$$\partial H_{building} = \partial \theta L_{ladder} \cos \theta$$

The goal is to minimize $dH_{building}$ and since the angle resolution $d\theta$ is fixed, choosing a short ladder length makes θ large and $\cos\theta$ small, so the short ladder should be used. Strategy 2 is to measure the distance along the ground and knowing the ladder length get the building height. The critical measurement is the distance from the base of the ladder to the building:

$$H_{building} = \sqrt{L_{ladder}^2 - L_{ladder_base_to_building}^2}$$

$$\partial H_{building} = \frac{-L_{ladder_base_to_building} \partial L_{ladder_base_to_building}}{\sqrt{L_{ladder}^2 - L_{ladder_base_to_building}^2}}$$

The answer is still the same, use a shorter ladder. If the analysis does not seem intuitive, use it to create a spreadsheet and put in some characteristic numbers to "run an experiment":

Ladder Length (L)	5	7
Angle measurement	44.4	30.0
Actual building height	3.50	3.50
Building height with 1 degree error in angle measure	3.56	3.61
Error in building height determination	0.06	0.11
Baseline measurement	3.57	6.06
Building height with 0.01 m error in baseline measure	3.51	3.52
Error in building height determination	0.01	0.02

Consider the contest "The MIT and the Pendulum" where the score is the product of the total angular distance (revolutions + 1) traveled by the pendulum and the total weight (grams + 500) of the objects that end up in the bin. Should you focus your efforts on maximizing the weight of the objects in the bin, or maximizing the total angular distance traveled? Are there ways to simultaneously increase both? How can you minimize either of your opponent's values? It is the mark of a good contest when it is not immediately obvious how to easily get a large score; and in this type of situation, where the scoring algorithm includes an initial set value, two independent machines might form the basis for a robust strategy. When pursuing a two-machine strategy, a large team is normally divided into two design teams who work in close conjunction, yet each team can focus on their own design. For the case of a single person robot design contest, use the coarse-fine approach by developing both machines simultaneously to the module level, and then finish one machine and test it before finishing the other machine.

Look carefully at the scoring algorithm and the table itself. Write a spreadsheet that lets you play with different combinations of scoring elements to predict what is the best way to maximize your score. Play with the table and determine which scoring method, getting weight into the bins or getting angular distance on the pendulum, would be easier for you to accomplish. Often multi variable design problems are optimized differently by different people, and there is often more than one "optimum" solution! The winner will have achieved robust implementation and have had lots of driving practice!

Analysis: *Scoring Sensitivity*

- What gives the greatest score for the least effort:

- Pendulum?
- Hockey pucks?
- Balls?

- What variables affect the score?

- Ball and puck weight
- Pendulum travel?
- ?

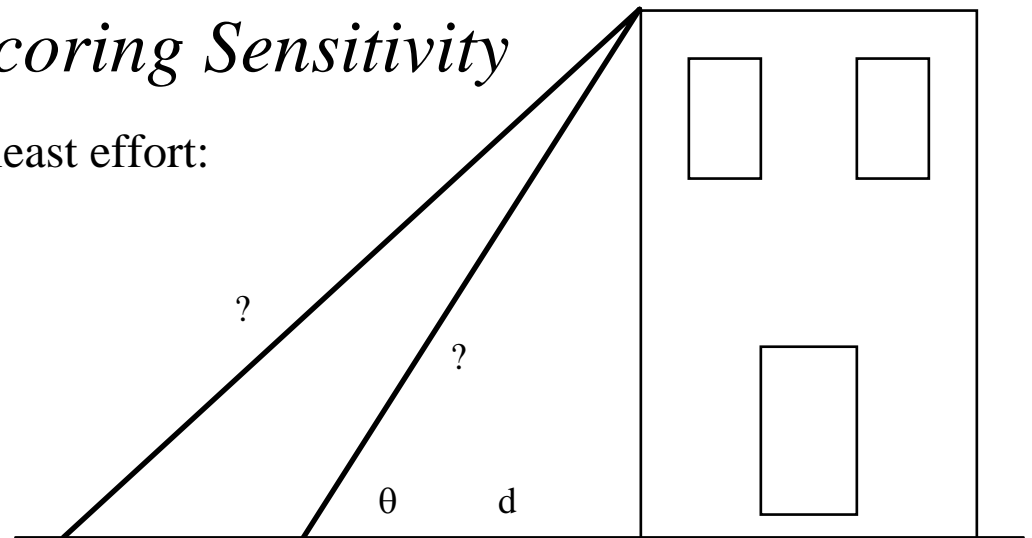

- Answer these questions by writing the equations, and then investigating which are the most sensitive parameters

- Ask yourself: *How can I affect each of these parameters?*

- ***Physics is an AWESOME catalyst to help your brain generate ideas***

- ***Analysis is an awesome lens for focusing effort!***

$$Score = \left(\theta_{Total_#_pendulum_revolutions} + 1 \right) \left(m_{total_mass_in_grams} + 500 \right)$$

- ***The MOST critical thing you can do in a robot design contest, is study the scoring algorithm and determine which are the most sensitive parameters!***

- This will direct your efforts for the development of strategies and concepts!

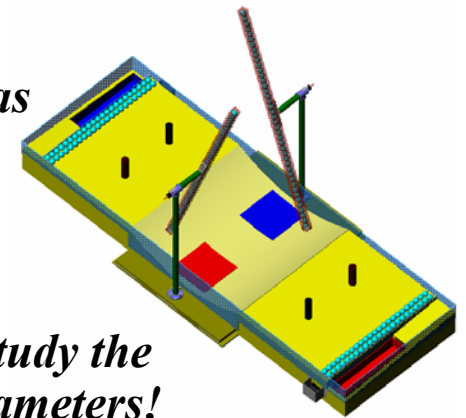

Analysis: *Appropriate Analysis*

An important factor to consider when doing an analysis of a physical problem is time. You have a limited amount of time to complete the project, so you typically cannot afford to do a molecular dynamics simulation of the problem. You have to use the correct type of analysis, because simple, wrong and on-time design is just as bad as complex, correct, and too late¹ design! To conduct *appropriate analysis*, the design process itself can be used².

Strategy: Do first-order calculations of power and motions required to achieve the different possible functional requirements. In the case of a robot design contest, calculate the power and trajectories required for the different scoring methods. Then you can match these to the different power and motion potentials of your kit elements and use these to help develop *strategies*.

Concept: Do first-order "back of the envelop" overall system power and geometry calculations to determine if your *concept* has a chance of working. These may include initial range of motion-to-machine size ratio considerations. If your *concept* requires 1.21 gigawatts of power, and you do not have prior knowledge of the time and location of a lightning strike, investigate another concept such as finding a source of plutonium to power your flux capacitor³. If you determine the power required is N Watts, and your power supply can deliver 2N Watts, it is OK to develop the idea.

Modules: The next step is to do a preliminary sizing of the elements available to see if they have the proper power, motion, and strength. If your overall power calculations indicate you need N Watts of power and your power supply can deliver 2N Watts, yet you are only given five N/2 Watt motors, you need a different *strategy*, or you need to figure out how to combine the output from the motors. For example, use one motor to drive each wheel of the car. Or if you were considering the use of a front-end-loader design, the bucket need only be raised to a height that is about ½ the vehicle's maximum height so a simple linkage design might accomplish the task.

1. There is an old saying that all data is real, its just the analysis that is often wrong. When appropriate analysis is used to design the experiment, the data will not only be real, it will often be as expected!

2. Chapter 3's discussion of Fundamental Principles can be of significant help in your quest for simultaneous development of ideas and analysis of the ideas.

3. From the movie *Back to the Future*. Maybe this example really did happen! This movie has some very good lessons about creativity!

Components: At this stage of the design process you have to do detailed calculations, often involving optimization. An example is selecting the wheel size and transmission ratio⁴. You previously determined that you could use four N/2 Watt motors, one on each wheel, if you are to achieve the N Watt total power requirement, and have an extra safety margin. However, you must consider that these are DC motors and the maximum power is achieved when they are run at half their no-load maximum speed; thus you must select a transmission ratio and wheel size such that when the vehicle is going at its desired steady state speed and putting out the required power, the motors are spinning at half their maximum speed.

Another example of component optimization is that of leadscrew pitch⁵. Once again, a DC motor should be run at half its maximum speed (and hence ½ maximum torque) to achieve maximum power. When determining the maximum power one can get from a leadscrew, it should be based on these motor parameters. If one were really serious about optimizing the system, one would also consider the motor inertia, which should match the leadscrew and load inertias.

As an example of *inappropriate analysis*, consider the sizing of a belt in a belt drive⁶. Steel or polymer belts are often used, and when the belt bends around a pulley, the stress in the belt is a function of the belt's thickness, Young's modulus, and Poisson ratio, and the radius of the pulley. The belt cross section must remain rectangular because it is very thin, which results in plane strain; as compared to a beam which can be tall compared to its width; so a rectangular cross section becomes slightly trapezoidal when bent, resulting in plane stress. If the simpler plane stress calculation were used for the plane strain problem, the stress would be underestimated by 10%, which could have a significant impact on fatigue life and hence machine maintenance.

Conduct appropriate spreadsheet or MatLab™ based analysis on the design contest and your ideas. Does an estimate of the power and motions give you any indication of the design's feasibility? Does it help you think of new *strategies* or *concepts*?

4. See Chapter 5 for a discussion of optimal transmission ratios.

5. Leadscrews, and a spreadsheet for their design, are discussed in detail in Chapter 6.

6. See Chapter 5 for a detailed discussion of the design of belt drives.

Analysis: *Appropriate Analysis*

- Appropriate Analysis is a **CRITICAL** part of defining a problem's bounds and generating creative concepts!
 - If $F = ma$ will answer the question, do NOT bother with relativity!
 - Spreadsheets, MATLAB, FEA....use whatever works best for you to yield an informative and insightful answer in the least amount of time
 - Remember to use analysis to design experiments, and experiments to answer questions when analysis is too difficult
 - If you spend your time pushing on a rope, you will buckle from the strain!
- “Back-of-the-envelope” calculations are a critical part of the early conceptual design phase!
 - Kinematic constraints
 - Beam stresses
 - Power required
 - Tractive force
 - Tipping angle
 - ...
- Too many designers put-off analysis until its too late, and they are stuck trying to detail a design that fundamentally draws vacuum (S%\$KS!)

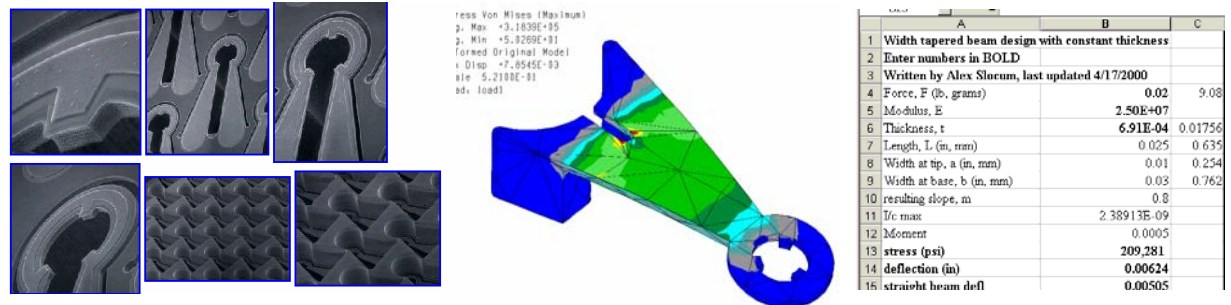

Analysis: Geometry, Time, & Motion

The creation of a *strategy* often involves creating simple diagrams with arrows to indicate motions that might occur. The selection of the best *strategy* will likely require some basic calculations to determine the feasibility of making these motions in the allotted time. *Beware of sketching lots of pretty pictures and then selecting the “best idea” based on happy thoughts and group good-feelings consensus!* A significant amount of analysis should/could be done on just the simple little arrow diagrams! For example, in the design of vehicle-based robots, consider the time to move in a straight line from a starting point to a stopping point. The additional elements to consider are traction and the torque speed curve of the motor/gearbox. You do not want to spin your wheels without moving! Can your wheel size be chosen to work with the motor/gearbox to give you the desired performance?¹

By means of example, let's focus on *The MIT and the Pendulum* contest to illustrate the idea of basic geometry, time, & motion calculations to roughage an idea before it solidifies. The first step is to ascertain the dominant system physics? Since the scoring objects' masses are limited, but the pendulum can be made to swing a lot, it seems to make sense to focus on the pendulum and getting the balls out of it so it will be balanced and thus free to spin:

Moment of inertia of balls, J_{balls} (Kg-m²)	0.0040
Total pendulum moment of inertia, J_p (kg-m²)	0.43
Total pendulum mass, m_p (kg)	2.18
Location of center of mass from pivot, r_{cm} (m)	-0.018
Displacement and velocity calculations	
Angle from hanging vertical to raise, θ_{dump} (deg)	110
Angle at which drive system loses contact, θ_{push} (deg)	20
Increase in potential energy, PE (kg-m ² /sec ²)	0.50
Required angular velocity, ω_{pend} (rad/sec)	1.52
Required tip velocity, V_{car} (m/sec)	1.74

Thus a simple strategy is to cause the pendulum to start swinging. Several concepts come to mind, including just starting with a basic fast-moving bulldozer that could start your pendulum swinging fast enough to dump the

balls, and then maybe the bulldozer could go have fun with the opponent? Is this feasible?:

Concept 1 Calculations: Push from standing start	
Distance between pendulum tip and arc surface, d_{pa} (m)	0.010
Distance available for travel, d_{travel} (m)	0.405
Acceleration to achieve velocity in distance, a_{req} (m/sec ²)	3.75
"g's" acceleration required	0.38
Coefficient of friction between wheels and ground, μ	0.38
Max attainable coefficient of friction, μ_{real}	0.50
Min distance required for V_{car} given μ_{real} , d_{real} (m)	0.31

This seems feasible, but is there a better way? Would it be better to get a running start and impact the pendulum to really send it spinning?:

Concept 2 Calculations: Conservation of energy and momentum	
Distance to travel to impact, $d_{travel2}$ (m)	0.405
Vehicle mass, $m_{vehicle}$ (kg)	4
Reasonable acceleration, a_{real} (m/sec ²)	4.9
Velocity at impact, v_{impact} (m/sec)	1.99
Equivalent linear point mass of pendulum, m_{pend} (kg)	0.328
Resulting tip velocity after impact, $V_{tipimpact}$ (m/sec)	3.68

But wait, if you are planning a vehicle to spin your pendulum and then go play with your opponent, your opponent is likely think the same thing! So maybe build a castle and spin and protect?:

Concept 3 Calculations: Castle-based spring launchers	
Constant force spring force, F_{spring} (N)	11
Constant force spring travel, X_{spring} (m)	0.25
Number of springs, N_{spring}	4
Mechanism efficiency, η	50%
Total spring energy, KE_{spring} (kg-m ² /sec ²)	5.5
Spring KE/Pendulum PE Increase	11

What other *strategies* and *concepts* can you envision? Perform the appropriate analysis to evaluate them and to play “what-if games”! An afternoon of analysis can save weeks of work the shop!

1. Chapters 5 & 6 focus on the topics of actuators and optimal transmission ratios

Analysis: *Geometry, Time, & Motion*

- The contest only lasts for N seconds, so do you have the time (and the power!) to do what is needed?
 - Maximum motor power is generated at ½ the motor's no-load speed!
- A simple spreadsheet can help answer these questions
- Check out *garmotor_move.xls* and its discussion in Topic 7
 - Those who succeed in design are usually explorers...!

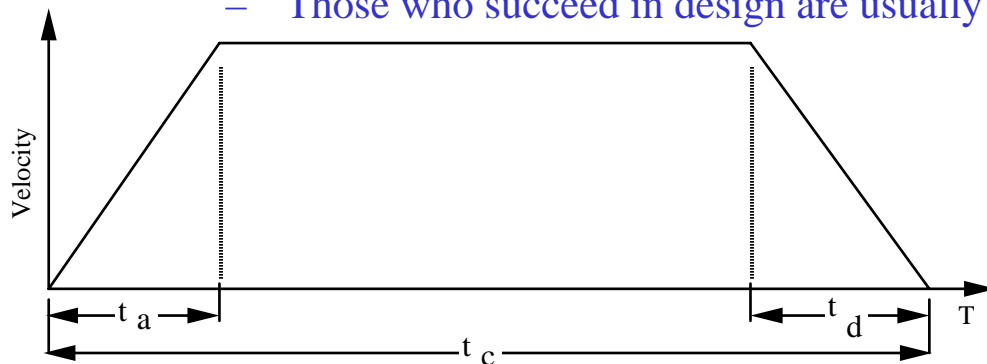

$$D = \frac{a_{\max}}{2} \left(\frac{t_c}{3}\right)^2 + \left(\frac{a_{\max} t_c}{3}\right) \left(\frac{2t_c}{3}\right) + \frac{a_{\max}}{2} \left(\frac{t_c}{3}\right)^2$$

$$a_{\max} = \frac{9D}{2t_c^2}, \text{ maximum acceleration (m/s}^2 \text{ or rad/s}^2\text{)}$$

$$v_{\max} = \frac{3D}{2t_c}, \text{ maximum velocity (m/s or rad/s)}$$

$$X_{car} = F_{\max} \left[\frac{M}{s^2} \left(1 + \frac{s}{M} t + \frac{1}{2!} \left(\frac{s}{M}\right)^2 t^2 + \frac{1}{3!} \left(\frac{s}{M}\right)^3 t^3 + \dots \right) - \frac{M}{s^2} - \frac{t}{s} \right]$$

$$X_{car} \text{ for } st/M \ll 1 \cong \frac{F_{\max} t^2}{2M} \quad t \cong \sqrt{\frac{2MX_{car}}{F_{\max}}}$$

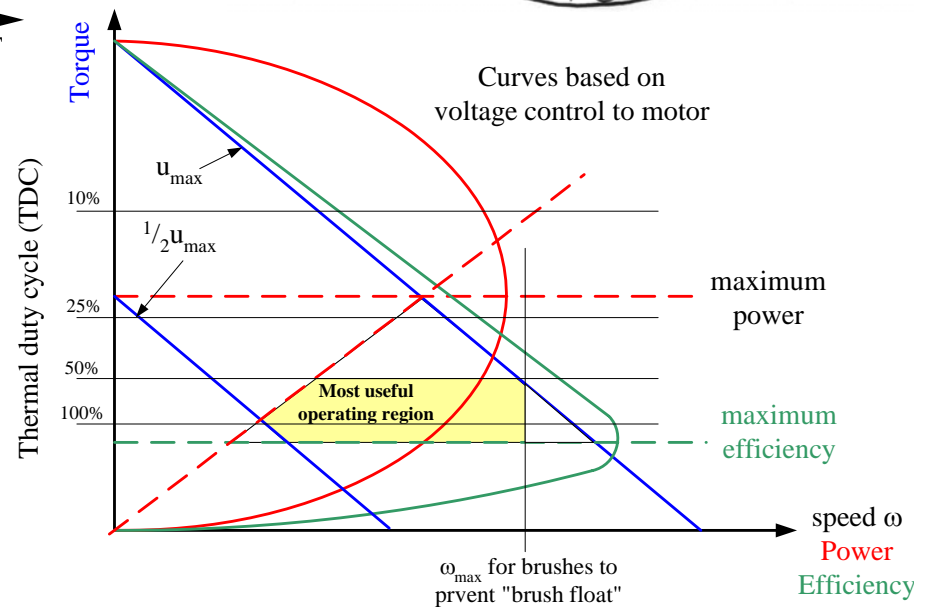
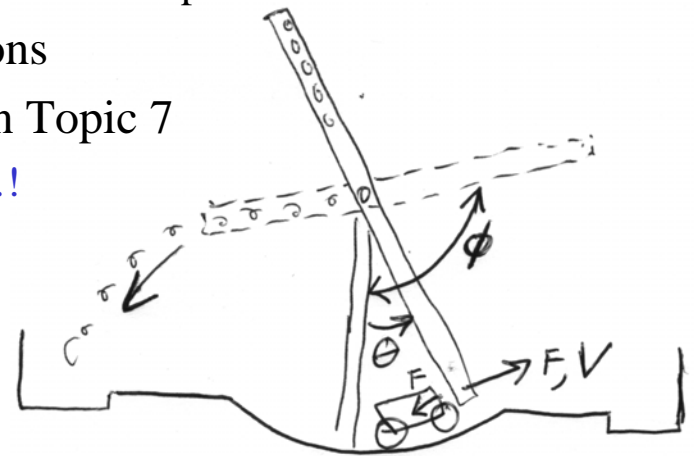

Analysis: Energy, Momentum, & Strength

Concept 2 on the previous page relies on imparting enough kinematic energy to the system to swing the pendulum to cause the balls to roll out on a trajectory towards the scoring bin. This uses one of the most useful laws design engineers have at their disposal, the conservation of energy:

$$\int F dx = \frac{1}{2} m v^2 + mgh$$

It must be noted that the use of the term F is intended to be a generalized force, for the effects can also be, for example, electromagnetic; hence the term ds is also generalized and does not only mean distance. In other words, in a system, the total energy is constant, and applied energy inputs or losses, such as friction, are accounted for by the total work (force*distance = work = energy). One has to be careful to remember that work is only done on the system by a force when there is displacement. The normal force on a block sliding on a plane does no work because there is no displacement in the direction of the normal force; however, the resulting friction force does do work on the system in the form of dissipating energy.

In the example of the pendulum with inertia J being given an initial angular velocity ω to raise the center of mass by an amount Dh from its plumb hanging position to an angle at which the balls roll out, the losses are minimal and can be ignored for now:

$$\frac{1}{2} J \omega^2 = m_{\text{pendulum_mass}} g \Delta h_{\text{center_of_pendulum_mass}}$$

$$V_{\text{tip_velocity}} = \omega L_{\text{Pivot-to-tip}}$$

Mechanical systems are often subject to collisions, and in the case of elastic systems where there is no dissipation of energy by plastic (permanent) deformation or viscoelastic deformation, conservation of momentum is maintained: The sum of the momenta of elastic bodies before the collision equals the sum of the momenta of elastic bodies after the collision. In a laboratory reference frame:

$$\sum m_i v_{i_initial} = \sum m_i v_{i_final}$$

Note that the sound produced by the collision does dissipate energy, and an exact model would have to take this into consideration if using conservation of energy relations; however, this would be inappropriate analysis for this phase. Consider **Concept 2** where the pendulum is at rest and a vehicle rams into it in an attempt to give the pendulum enough kinetic energy to make it arc up and dump the balls. Conservation of energy and momentum are respectively:

$$\frac{m_v v_{v2}^2}{2} + \frac{J_p \omega_p^2}{2} = \frac{m_v v_{v1}^2}{2}$$

$$m_v v_{v2} + \frac{J_p \omega_p}{r_p} = m_v v_{v1}$$

Solving for the velocity of the vehicle after impact in the momentum equation and substituting the result into the energy equation and solving for the required velocity of the pendulum at the tip radius, r_p , tells us how fast the vehicle must be going when it impacts the pendulum:

$$v_p = r_p \omega_p = \frac{2v_{v1}}{\frac{J_p}{m_v r_p^2} + 1}$$

The fact that the vehicle is powered and keeps pushing even after impact, otherwise it would slow down, makes this analysis conservative and helps to reduce risk. *What appropriate analysis will enable you to estimate the stresses in the system?* Note that if we were worried about the stresses of impact, coil springs, which are elastic with very low energy loss, could be used as bumpers to cushion the impact without reducing the final velocity of the pendulum.

What other energy transfer means can you think of that might help you raise your score? Is it feasible to just store the energy in springs and then release it directly into the pendulum? Are there springs in the kit sufficient for this purpose?

Analysis: *Energy, Momentum, & Strength*

- 1st check for the feasibility of a design: Is available $\text{Power}_{\text{available}} > \text{Power}_{\text{required}}$?
 - Example: Can I raise the pendulum through a 30 degree arc in 1 second using energy stored in constant force springs?
 - $mgh < FL_{\text{extension}}$
- 2nd check for the feasibility of a design: Is $\sigma_{\text{yeild}} > \text{applied stress}$?
 - Example: Can I hold M kg extended out L m on a telescoping truss with H m cross section made from D mm welding rod?

$$\sigma = (MgL) \left(\frac{\pi D^2 H}{2} \right)$$

- It is a good idea to be aware of the physical capabilities of the kit materials, and the physical requirements of the scoring methods...

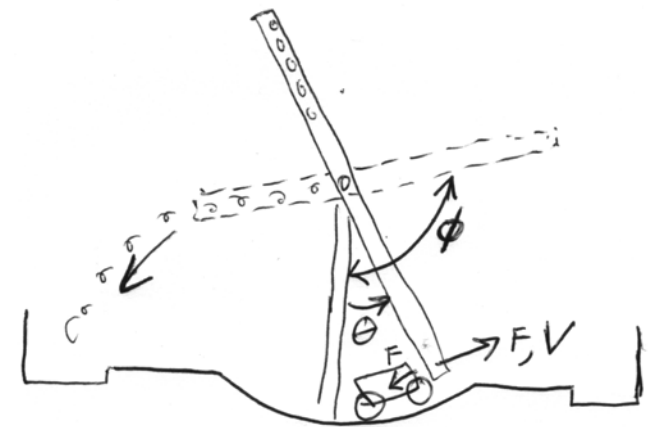
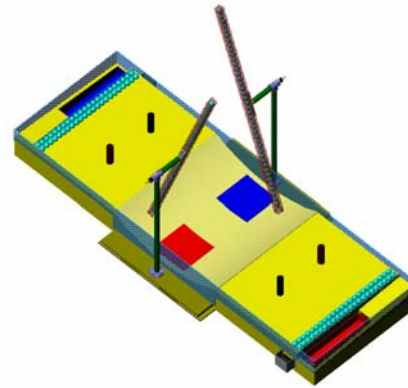
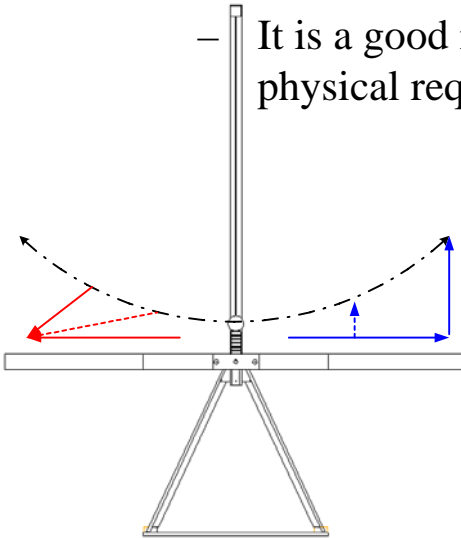

Evolving Systems

Chapter 1 focused on design process and how it can be used to enhance creativity and manage it to enable engineers to better achieve project performance and schedule goals. This chapter has thus far focused on thought processes that can help an engineer generating and creating ideas. This final section will focus on system issues, including how engineers can more effectively work together in a team, without having to give up their individualities. Engineers must focus on their design task, but like a good optical system, they must have good depth in their field: they must be able to also focus on the broad needs of the system to ensure that their piece of the action is compatible with all the other pieces. Thus regardless of what part of a machine an individual is responsible for, or a single engineer happens to be developing at the time, the engineer, if they are truly to be a great team member, must keep an eye on all the parts of the system:

- Structure and Geometry: What is the overall physical framework and what space does it require and what loads must it withstand?
- Kinematics/dynamics: What are the required/possible motions, speeds, and loads?
- Bearings: How will moving components be supported?
- Actuators: How will components be actuated and what are the power requirements?
- Sensors & Controls: What sensors are required, and what control system, including software, is required to process the data and operate the system?
- Manufacturing: How will all the components be manufactured, assembled, and tested?
- Maintenance & Support: How will the system be maintained and what types of customer support will be required?
- End-of-life: What happens to all the pieces when the system comes to its end-of-life? Can it be taken apart as easily as it was put together?

The glue that ties the team together should be awareness of the attributes and risks associated with each part of the system. The goal needs to be to minimize overall cost and risk and maximize overall performance. For complex systems, careful systematic dissection and analysis of the problem is the best way to succeed. Risk WILL be encountered, but risk represents opportunity and thus it is neither to be feared nor ignored, but rather it is to be

managed by continual evaluation. Perhaps the best way to be an effective team member is to first do it alone so you can better appreciate how much stuff there is to do, and how easy it is to miss some minutia that later turns out to be a critical factor. Then when you are a member of a team, you will be able to contribute better, as well as coach others to be better contributors. You **MUST** become good designer in your own right, if you are to function well in a team.

Some people love teams and some people hate them, but the fact is humans are social life forms, and everything we have is because of teamwork catalyzed by individual spirit and drive. A good manager and a good team can create a positive experience for all if a passion catalyzed deterministic process is used to create and develop ideas. This process involves letting individuals first be individuals, and then gradually blending and evolving ideas:

- Individual thought:
 - Often the most creative.
 - Do before people are influenced by others.
- Peer Review:
 - First individual, and then group analysis and discussions, offer the best of both worlds.
 - Preloads all people to know what other team members are thinking.
- Group brainstorming:
 - Greatest breadth of resources applied collectively.
 - **MUST** do Individual and Rohrbach stages first!

Consider contests where individuals must create, develop, build, test, and operate their robots. This, however, does not mean that you cannot share ideas and discoveries with your classmates. In the real world, companies often are friendly competitors where they develop and share pre-competitive technology because they know when they give a gram, they often get a kilo back from the group. Final success is a strong function of how well ideas are implemented, how robust the final product is and how well it is supported.

What technologies are common to most ideas that have evolved? Can these generically required ideas be developed and shared by the students in your lab section? How about mounting motors, or bearings or gears or wheels? How about wiring and use of the control system? What is the best way to design and cut gears and layout, cut and bend sheet metal?

Evolving Systems

- Individual Thought
- Peer Review
- Brainstorming
- Comparing Designs



Colin Bulthap



1998's *Balcano!*

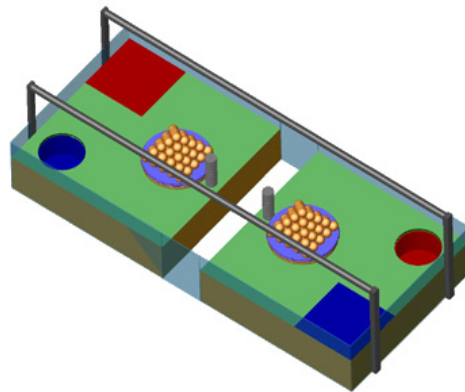
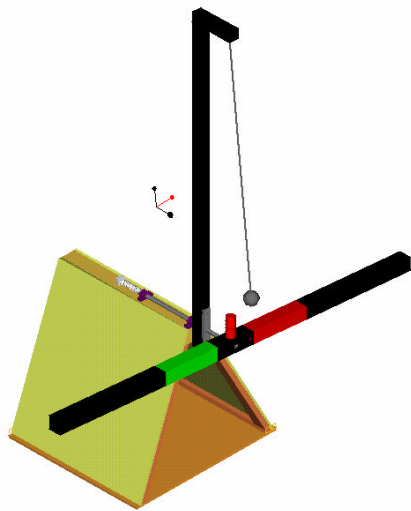
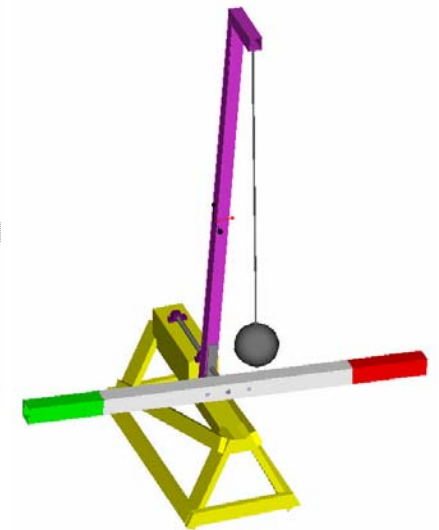
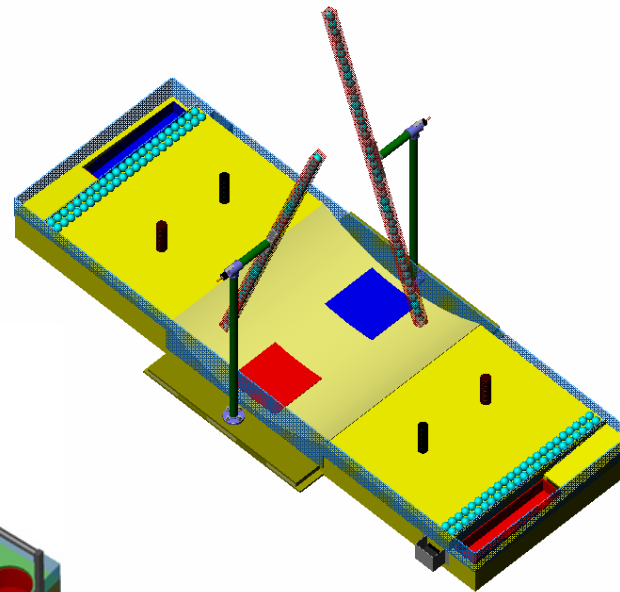
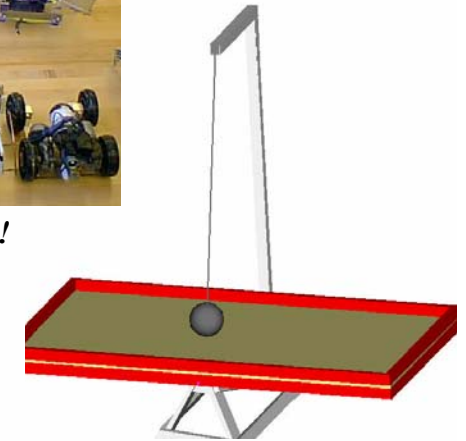

Evolving Systems: *Individual Thought*

Pendulums tend to swing with very predictable dynamics. The problem occurs when pendulums are added to pendulums and compound motions start to occur. So it is with complex ideas, and indeed the problem becomes even more chaotic, if that even seems possible, when teams of people become responsible for bringing a complex product to market. So how are complex projects ever completed, and what role does the individual play? The answer is that good products come from good *project management* by a *strong visionary leader* who is aided by *competent creative individuals*.

Indeed, very few products can be developed by individuals; on the other hand, very few teams can function without strong leadership. It takes a team to do everything from identifying the need, to creating and developing the idea, to producing, distributing, and supporting it. However, the weakest link in the chain is still the individual be it an engineer, machinist, or manager. When faced with a difficult problem, an individual must not think “someone else will take care of that”. The individual must either plan on addressing the problem (opportunity!) or determine who exactly will handle it. In this manner, critical things will not be overlooked. Remember, all it took was a simple O-ring embrittled by the cold to cause the Space Shuttle *Challenger* to blow up in 1986! An individual engineer thought of the problem and passed the thought on to an individual manager who did not think that the risk was significant. A failure of individuals’ thought processes led to the demise of the team, including the astronauts.

Hence the first stage in the development of a team must be the development of the individuals. Each individual must first learn their strong and weak points and their limits; thus when they are on a team, they will know when to volunteer, and when to ask for help. Bravado can not only hurt yourself, it can hurt others. Do you want to be responsible for other people losing their jobs because you were not doing yours? The first step in teamwork is for each individual to recognize early on in their educational pursuit of a degree that they will one day be a member of a team. They must realize that other people will not be there to carry them, so study hard and efficiently. It means the smarter you learn¹, the more fun the entire team will have! Education is not a game, it is your future, so you must learn to learn in whatever form information is available, and to never stop learning!

Now that the house is heated, the first step a team takes after being assembled, is to take a first-pass at defining the problem (opportunity!); however, the team must not start suggesting *strategies* or *concepts*. This would likely pollute individuals’ thoughts. Accordingly, the next step is for the individual team members to disperse and go think about the problem by themselves. In this mode, the individual’s job is not only to think of *strategies* and maybe some *concepts* to solve the problem; the individual must also ask the question “did the team really define the problem, or maybe the real opportunity is...?”

In order to best do this task, the individual should play with the problem, and bend it, twist it, pull it... The individual needs to extricate themselves from the fray and let their mind be free and unencumbered of confining boundary conditions. Taking walks is one of the best ways to get the creative juices moving. Baths and swimming endless laps are also great ways to get the ideas flowing. Putting all ideas down on paper helps to solve the mystery. Singing songs about the solution can also create a melody of ideas. Thinking while preparing elaborate meals can also get your idea generator cooking!

The most important thing of all, however, is to alter your states while thinking. From physical relaxation, to physical exertion, think about the opportunities the problem presents, including the potential to redefine the problem, and how you might develop a *strategy* to solve it. From massive endorphin release to total panic about not having enough time to complete the project, think about possible *strategies* and *concepts*. And to catalyze it all, scan through technical journals, trade magazines, and web sites in many different fields!

After all this is done, gather your thoughts and arrange them in FRDPARRC tables. Let the tables speak to you, and select very risky, moderately risky, and no problemo *strategies* and possible *concepts* to bring to the team for consideration.

Do all the above to define the contest goals, create the appropriate FRDPARRC tables and develop *strategies* and *concepts*!

1. The author learned his sophomore year to apply essentially the design process that is presented in this text to his schoolwork, and was then able to zoom through school while maintaining a healthy diet of extracurricular activities of various fun forms; although he admits he did not start snowboarding till the early 1990’s.

Evolving Systems: *Individual Thought*



- Individual thought is often the most creative
 - Do leisurely things (e.g., long walks) that inspire creative thought
 - Look at what other people have created
 - Look in your home, stores, www, patents
 - Get out of traffic and take alternate routes
 - Sketch ideas and the ideas' principal components
 - Cut out the principal components and pretend they are modular elements
 - Like toy building blocks, try different combinations of components to make different products
 - Pit one idea against another and imagine strategies for winning
 - Take the best from different ideas and evolve them into the best 2 or 3 ideas
- Update the FRDPARCC table and create a *Milestone Report* or *Press Release* for your favorite ideas
 - The FRDPARCC Table (ONE DP per FR) and a large annotated sketch makes an effective infomercial
 - A random person should be able to read your *press release* and fully understand your idea without your having to explain it to them
 - These sheets will be shared with your teammates in the next stage...

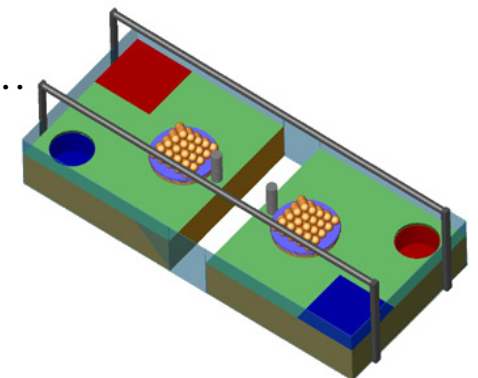
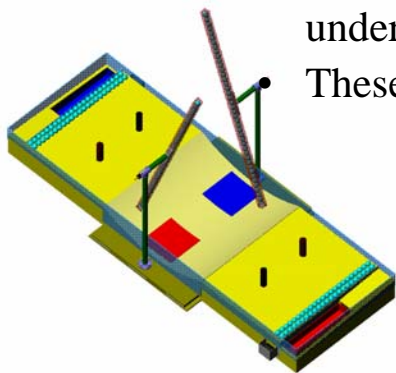

Peer Review Evaluation Process (PREP)

When a group of creative people gather to discuss new ideas, often with donuts and coffee as a catalyst, an hour of discussion frequently does not result in consensus. However, if thinkers first summarize in writing (and drawing) their best individual thoughts and then circulate them for their peers (team members) to review, confrontation can be avoided and egos can be mellowed. Rohrbach defined a particular version of this process where six people each bring three ideas to the table, and then each person evaluates each other person's ideas without discussion¹. The evaluation is done without any discussion by writing thoughts and questions down on the papers that describe the ideas. Because people have to write their ideas down, ideas are often better formulated. This also gives reviewers the ability to easily sketch ideas that can enhance or solve a problem they may find with the idea. In addition, it is very useful to require that any negative comment be accompanied by a constructive comment that suggests how to rectify the observed problem.

Once all the reviewing is done, individuals review the comments that others made on their ideas, and any misunderstandings are cleared up. If time permits, the documents should once again be circulated so all the team members can see all the comments on all the ideas. This further helps to develop a better understanding of all ideas, and it helps team members to learn by observing what they might have missed. The team then breaks so that individuals can think about the comments they received, and about the other ideas they reviewed. They each know what the other members are thinking and their minds become one with each other. They are now PREPed for brainstorming. Invariably the loud aggressive person who is used to having their ideas accepted without question will ponder a really neat idea that the new shy quiet person had, so when the team reconvenes for brainstorming, the truly best idea is most likely to bubble up to the top.

This coming together of minds to learn about other team members' ideas without discussion has a very important psychological effect. It allows people to constructively criticize and be criticized without confrontation. It

allows shy people to have their ideas be brought forth where otherwise they might never be presented for fear of rejection. Furthermore, it establishes a written record that documents the thought process. This enables others in the future to go back and see if the team considered some particular facet of the problem. This can also be important for protecting ideas in the case of patent litigation. This also allows managers to see who is working and who is not!

Peer review of ideas before brainstorming thus creates and documents a collective mind, so everybody knows what everyone else has been thinking, thus giving egos a chance to mellow. In general, PREP works very well, but it depends on how well people seek to make it work. Teams have to try using PREP, subject to their own unique culture. The 4 steps are:

- Individual thought and document concepts
- Silent peer review
- Group brainstorming
- “Best” concept selection

In a teaching environment, PREP helps students learn to give and to constructively process constructive criticism, and to learn that others' different views often leads to exciting new ideas. PREP is a powerful tool for teaching the value of teamwork. It also helps students to acquire new skills, because when they see the work of others augmented by technology, it makes them want to learn how to use that technology (e.g., solid modeling). Furthermore, it helps students reach an equilibrium level as to what is the appropriate level of effort. The best students will always overproduce because it is in their nature. More mellow students will directly see the advanced effort of their classmates, and will be motivated. Finally, students will receive feedback on their designs without having to wait for a week for the instructor to grade them.

Work in a design review group with N members whose responsibility is to use PREP to evaluate each others ideas via commenting on weekly milestone reports. Get to know your group members and coordinate schedules to ensure that the milestone reports can be exchanged efficiently either by a weekly face-to-face meeting, or by exchanging documents via the internet. Keep track of the value of the comments made by your partners to see how they do, and make sure to provide them with feedback on the value of their comments. This is an important management skill. The amount of effort you put into this process will be reciprocated $N+$ times because you not only get feedback, you also learn by looking at the work of others.

1. G. Pahl and W. Beitz, *Konstruktionslehre*, Springer-Verlag, Berlin, 1977. Translated and published as *Engineering Design*, Design Council, London, 1984, pp. 87-88; and M. Graham, A. Slocum, R. Moreno Sanchez, “Teaching high school students and college freshman product development by Deterministic Design with PREP”, *ASME Journal of Mechanical Design* (Special Issue on Design Engineering Education), July 2007, Vol. 129, pp 677-681.



Peer Review Evaluation Process: *PREP*

♥Passion♥

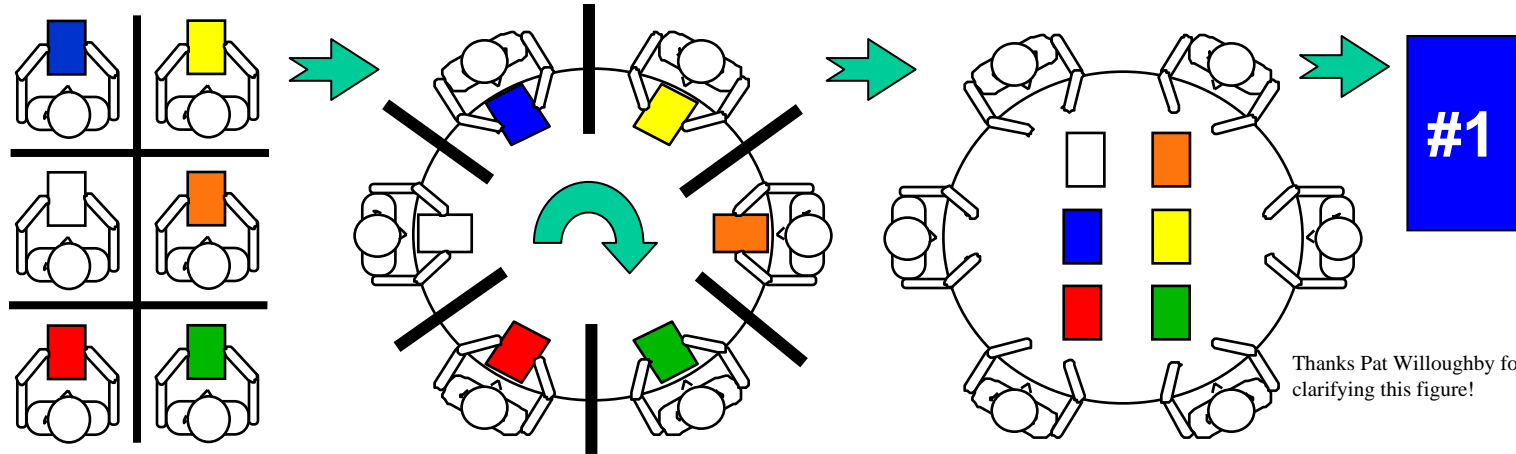

- There is no such thing as just an individual/Teams are made up of individuals
- Any design process must make the best use of resources: *individuals* and *teams*:
 - Give individuals pride of ownership:
 - Privately (think & create on their own, AND constructively evaluate the work of others)
 - Maximize the efficiency and effectiveness of teams and reduce apathy:
 - Do not have brainstorming meetings unless everyone is PREPared
 - Individuals must have thought of ideas and reviewed each other's ideas beforehand
 - Peer pressure will help correct non-performers and nay-sayers and reduce apathy



PREP: Example¹

The images show sketches made by a designer creating a GeekPLOW car for the 2.007 MIT & the Pendulum contest. Sketch (1) is a simple side-view *stick figure* that embodies the primary elements of the designers FRD-PARRC table. Can you imagine what might be the FRs and DPs? What *analysis*, *risks*, and *countermeasures* come to mind? [What would the comments from your peers help you to think about? If you were reviewing this idea, would you have any additional comments to add?](#)

Sketch (2) shows some more detail for the car, which evolved in parallel with playing with the spreadsheet on Page 7-16. Two motors would have enough power, but wheel slippage could occur, so it was decided to use 4 wheel-drive. Past experience (*references* in your FRDPARRC table) showed that connected sets of wheels on each side of the vehicle with belts or gears has never been effective, and thus to ensure high efficiency and minimal complexity of the car, four motors would be used. However, they can be wired in two sets of two, so we would still have two control channels left. With four motors driving, there should be no shortage of power, and enough vehicle speed could be obtained to enable the car to ram the balls and send them flying over the lip of the table into the scoring bin. In addition, the ramp could perhaps ram the puck stacks and make them fall onto the upper part of the ramp, and then they could fall into the scoring bin. [What would the comments from your peers help you to think about? If you were reviewing this idea, would you have any additional comments to add?](#)

Sketch (3) is a *layout* of the gearmotor/wheel most-critical-module. Note that as sketched in (2) two sets, mirror images, would have to be made. Is this bad? Should 4 identical units be made instead? What is the level of *granularity* of the elements in these modules? By fine granularity we would mean that most of the elements are identical, only the baseplate onto which the units were assembled would be mirror images. [Once again, what would the comments from your peers help you to think about? If you were reviewing this idea, would you have any additional comments to add?](#)

What is the next most important module? Probably the plow because it could be just a simple static plow, a default countermeasure, or perhaps a

more sophisticated unit as sketched. Making note of the FRDPARRC chart entries and then sketching a correlated element helps the idea to evolve: *Words trigger images, and the images highlight risks which catalyzes invention.* From this coarse layout sketch evolves more detail, where the next step would be to use solid modelling to further explore the geometry, or in some cases, analysis comes first. Before final commitment, a bench level experiment or bench-level prototype of this mechanism might be built and tested.

The result is a two-stage ramp/plow system shown in the sketch below. The rear link pivots and prevents the plow from raising the front of the vehicle as it collides with a rigid object. However, to prevent premature dumping, a trigger is used which must first impact the wall...

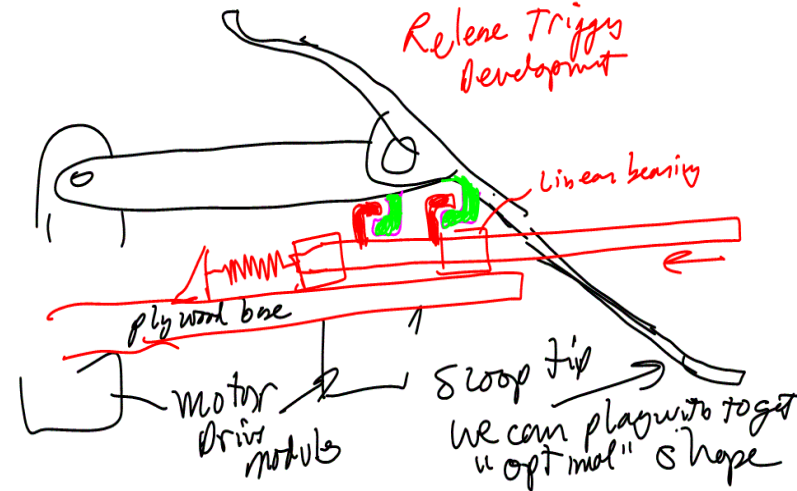

Sketch (4) brings it all together to show how countermeasures/design solutions evolved with risk identification: Just the way environmental pressures can cause a species to evolve, potential risks cause a design to evolve. This is the essence of the iterative process that we call *design*. [What comments from your peers would help you to think about this idea? If you were reviewing this idea, what would your additional comments be?](#)

1. For a more in-depth discussion of this example, see page 8-10...and follow the threads!

PREP: Example

- Appropriate detail for sketches and Peer Review Evaluation Process (PREP):

- Start pendulum swinging, use speed & then ram into ball
- Contingency is lift module on ram



idea added after sketch is think on next page - use speed to scoop and collect and then dump

Flips after ramming
pick collected by ramming

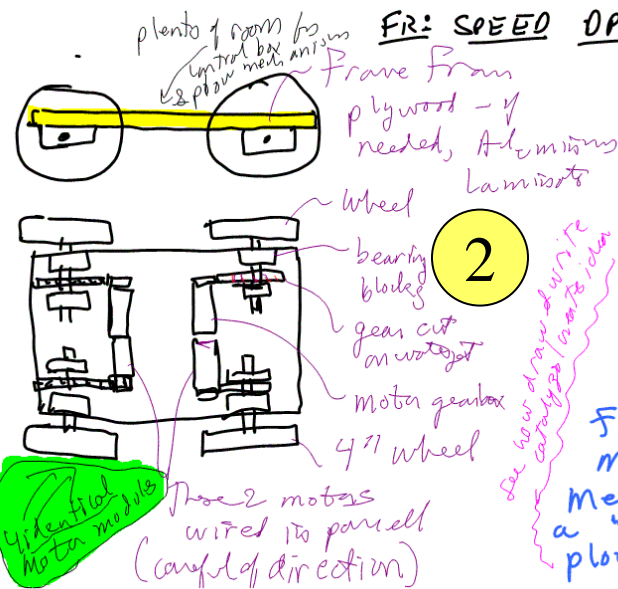

FR: SPEED DP: All Power to wheels!

Strategy: speed, Traction, mobility

Concept: 4 motors drive 4 wheels. get balls over the hump by ramming them. picks too - The fact that use all motors for wheels means need to create a "ramming activated plow ..."

See how driver of wire like see car body to make idea

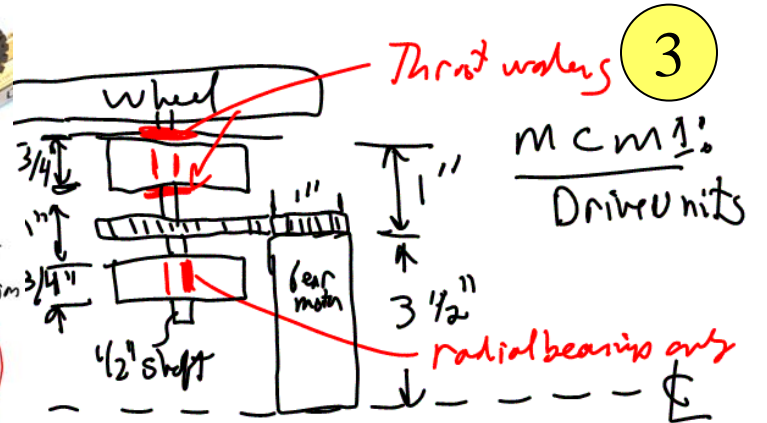
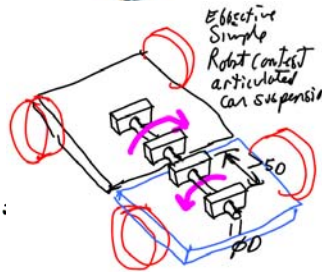
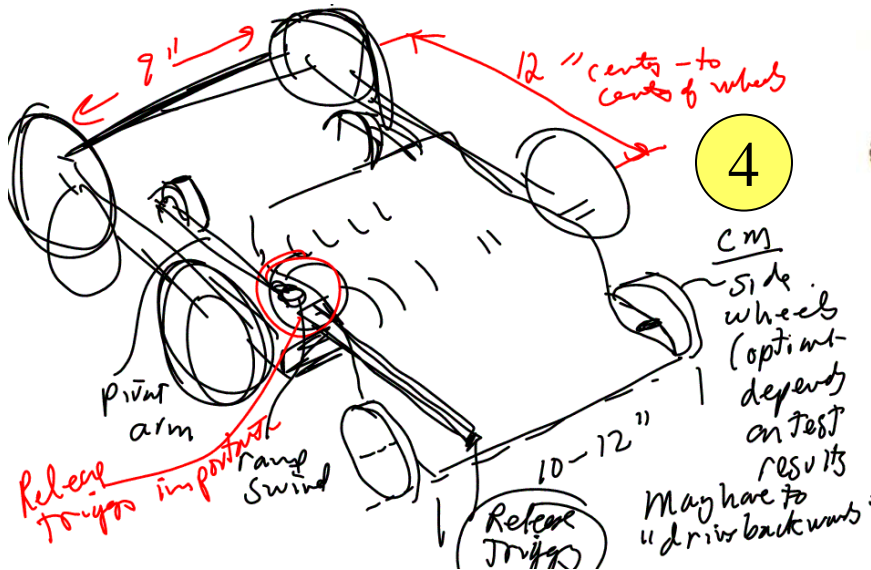

Evolving Systems: *Group Brainstorming*

The term *brainstorming* can have many different meanings to many different people, from the thoughts of an individual, to an informal group discussion, to a formal process for idea generation by a group. In general, the latter is the preferred connotation. Although the rules for conducting the process can vary significantly, in general, the goal is to encourage the generation of as many ideas as possible without any criticism being brought against any idea. If resources allow, a recording person who is not a direct contributor to the process should capture all the thoughts and comments. Then after all the ideas have been generated and grouped according to type, a discussion period follows where the pros and cons of each idea are discussed, along with suggestions for enhancing the performance of each idea.

There is an old funny that says a camel is a race horse designed by committee. This suggests that whenever consensus is reached, the compromises lead to an idea that is worse than any of its parts; however, camels are far superior to thoroughbreds when it comes to surviving in the desert. Therefore the issue is really one of focus. The team must remain focused on developing ideas to meet the functional requirements of the problem, and it is the job of the team leader to keep the team focussed.

To ensure that all the functional requirements, including those of manufacturability, business viability, and service are addressed, a team of brainstormers should have a broad background and should include not only engineers, but representatives from marketing, management, manufacturing, and service. Although this may seem like it could lead to decreased focus, each of these people will be required to make the product successful, and the earlier they can be brought on board as enthusiastic team members, the better.

The key to maintaining harmony and focus is to insist that no negative comments are allowed. People are only allowed to offer constructive criticism. In other words, if you are so smart that you can just look at an idea and see that the fragile pin will break, then you should also be smart enough to suggest a better design, or be smart enough to say "I am concerned about the loads on the fragile pin, and I think we should calculate them, and if they are found to be too high, we could switch to a canption pin". People should not be allowed to say "that design is useless because the fragile pin will shear".

An interesting way to expand the outcome of a brainstorming session is to assign a different team leader to different brainstorming sessions, where each session focuses on the problem from a different perspective. Also, once several "best" ideas evolve, different teams of experts should brainstorm on the evolution of the ideas. For example, when the focus is on manufacturing, there should be mostly manufacturing engineers in the room, but there should still be representatives from each of the other areas. When the ideas have then made the rounds, there will be better buy-in from the rest of the company, and the idea will have benefited from the insight of all the company's top people.

One of the best ways to ensure success from a brainstorming session is to have members who think individually beforehand and carry out the Rohrbach process. This ensures that team members come prepared, and come aware of each other's ideas so that a minimum of time is spent explaining basic concepts. This allows the session to start with all the ideas that have been commented on to be taped to the wall, and discussions can start with:

- Are there any functional requirements that we initially missed?
- Are there any ideas that stand out as clear winners?
- Are there any combinations of ideas that stand out as clear winners?

Finally, brainstorming is not just for creating ideas that solve problems, it can be used to identify problems in the first place. Accordingly, it can be applied anywhere in the design process from **Coarse-to-fine**. Unforeseen problems often crop up, which is part of the risk inherent in any project. It is important that all team members realize that when they encounter a problem that they cannot solve with modest effort, that they invoke the power of the team to help solve the problem. This represents the use of the nested cost-performance curves discussed on page 1-6. If you find yourself spending more and more time trying to identify or solve a problem, and realizing less and less progress, invoke the power of the team!

[Use the brainstorming process to identify common problems that you all face, and then think individually to create solutions to these problems. Next use the PREP and brainstorming processes to develop solutions you can all use in your individual designs. An example would be the best way to make crawler tracks or a four-wheel drive system for a vehicle or a leadscrew drive to actuate a bucket loader.](#)

Evolving Systems: *Group Brainstorming*

- Brainstorming helps teams solve personal creativity deadlocks and help to ensure something hasn't been overlooked
- Initially let everyone voice their suggestions, then distill ideas
- Group personality factors must be considered:
 - Shy individuals getting run over
 - Aggressive individuals always driving
- An individual's personality often has nothing to do with creativity
 - Careful to avoid conflicts over the issue of who first thought of the idea
 - The people in the group must be willing to take praise or scolding as a group
 - NO pure negatives, only observations with suggestions for improvement:

~~• “That design sucks!”~~

• “I see a low pressure region that can be alleviated by making it blue”

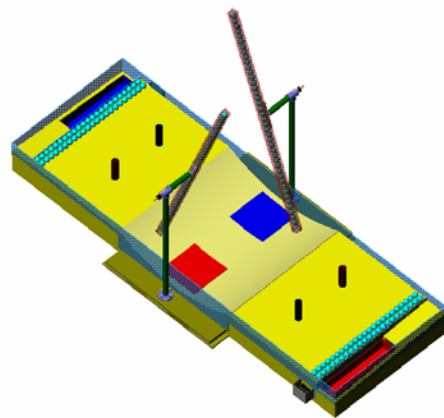
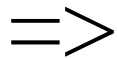
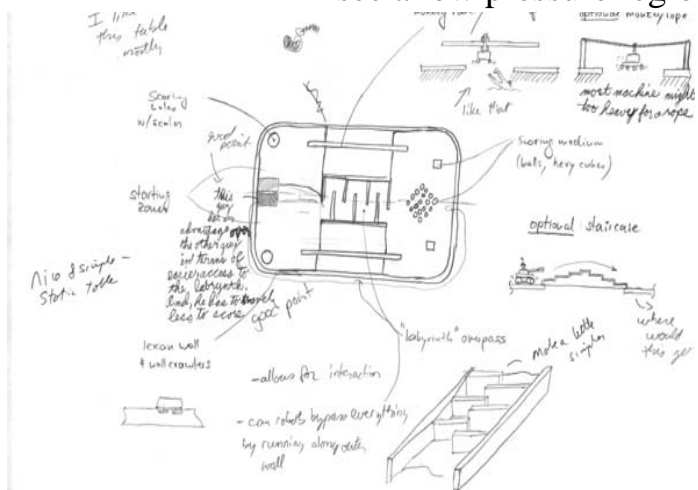

2-27

DILBERT: © Scott Adams/Dist. by United Feature Syndicate, Inc

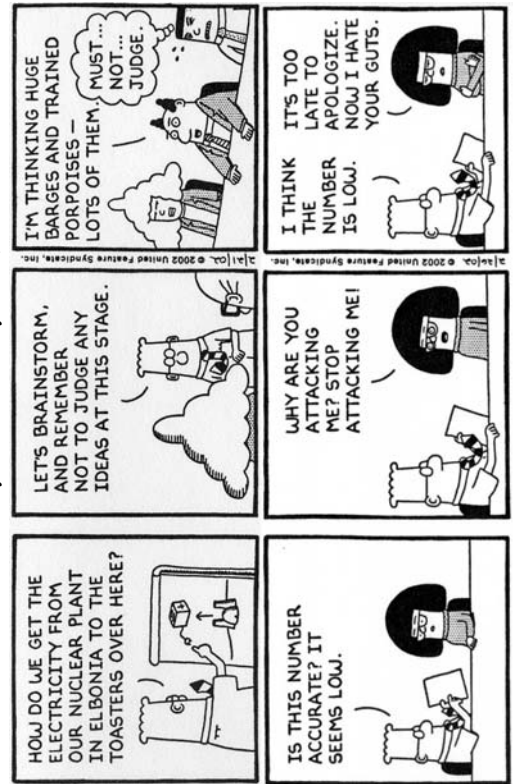

Evolving Systems: *Comparing Designs*

Selecting the “best” idea from several good contenders is often one of the most difficult aspects of design. Casting aside the really bad impossible ideas is often easy, so why should it really matter which potentially good idea is selected? The issue is that a “bad idea” may be considered bad because it is deemed too risky. In reality we often worry that later we will see with our 20/20 hindsight how good of an idea it really was, especially when someone else then develops it and impacts our glutes with it! Unfortunately, this can be a problem with consensus based team development of an idea. 9 of the 10 people on the team may mean well, but they may just not have the experience and knowledge of the shy quiet geek, and thus the team may select the wrong idea. Hence a process is needed for the ultra geek’s mind to be heard by the herd.

One of the intrinsic problems with various evaluation methods is that different people place different emphasis on different functional requirements, even though their votes count equally and the functional requirements may not have the same effect on product performance. Instead of trying to compare all factors at once, it would make more sense first to determine the relative importance (priority) of each characteristic (e.g., accuracy versus friction, accuracy versus cost) at each level in the outline of design attributes (functional requirements) and then evaluate the relative characteristics of each component with respect to the most explicit characteristic (e.g., straightness, smoothness, static friction, and so on). This type of decision analysis is called the *Analytic Hierarchy Process* (AHP)¹. The AHP method enables a team to structure a system and its environment into mutually interacting parts and then to evaluate their relative importance by measuring and ranking the impact of these parts on the entire system. This provides a **Coarse**-to-**fine** method for evaluating ideas.

Quality Function Deployment (QFD) also known as the *House of Quality*, is a matrix-type idea comparison method that is widely used in industry². QFD is a methodology for defining the customer requirements (left hand column) and mapping how they are affected by the design parameters of the problem (top row). The relations or interactions between the design parameters are also mapped and form the “roof” of the house. Additional matrices

allow benchmarking between products³. These methods are used in more advanced design courses⁴.

Prof. Stuart Pugh⁵ took the approach that these sorts of methods are powerful, but engineers may spend more time creating matrices and evaluating options than they do creating ideas. His approach was to call for a table, now referred to as a *Pugh Chart*, that lists the different ideas in the top row, and the comparison attributes or functional requirements in the left column. A baseline idea is selected, given it a score of "0" for each attribute. All other ideas are then compared giving them scores from "++" for far superior, to "+" for superior to "0" for equal to the baseline, to "-" for worse to "--" for much worse than the baseline. The "best" idea is the idea with the highest score; however that does not mean that this is the idea to use as is. Rather the goal is to then go back to the table and see which other ideas have higher individual ratings for some of the functional requirements, and then to see if their particular "++" attributes can somehow be used by the "best" idea; thus evolving the idea into a truly "best" idea. A *weighted design comparison chart* uses the same basic ideas as a Pugh Chart, but it includes a weighting column for weighting the importance of the design attributes. A compromise is to start with equal weights, and then if convergence is not reached, consider giving priority to some of the attributes. Again, the prime purpose of the chart is to identify the most promising ideas, and then replace whatever deficient modules they have with better modules from other ideas.

Create a weighted design comparison chart for your **strategies** and **concepts** and use it to help evolve "best" ones. Was it necessary to weight the functional requirements? How else would you have selected the "best ideas"? Try using this process by yourself and also with your design review group. Whenever there is a risk, make sure to have completed the appropriate analysis to help you turn the discussion from how do you “feel” about an idea, to how do you “think” about an idea! Feelings are for friends, but analysis, be it analytical or experimental, is for ideas!

1. T. L. Saaty and J. M. Alexander, *Thinking with Models*, Pergamon Press, Elmsford, NY, 1981.; and T. L. Saaty *The Analytic Hierarchy Process*, McGraw-Hill, New York, 1980.

2. D. Clausing, *Quality Function Deployment*, MIT Press, Cambridge, MA USA, 1994

3. K. Otto, K. Wood, *Product Design*, Prentice Hall, Upper Saddle River, NJ, USA 2001

4. M. Martin, S. Kementa, K. Ishii, “QFD and the Designer: Lessons from 200+ Houses Of Quality”, *World Innovation and Strategy Conference*, August 1998, Sydney, Australia, pp 49-59

5. B. Ion, *Pugh's Total Design: Integrated Methods for Successful Product Design*, Prentice Hall, NY, NY, 2000

Evolving Systems: *Comparing Designs*

- There are many methods available for evaluating design alternatives
 - The simplest method is a linear weighting scheme:
 - You may want to use the list of FRs as the evaluation parameters
 - Apply a relative importance weight to each evaluation parameter
 - Pick one design as a “baseline” (all zeros), and compare the rest (+ or -)
 - Easiest to use provided user bias can be minimized
 - When you find the “best” design, look at other designs and see how the + characteristics can be transferred to the “best” design to make it better!
 - A “Pugh” chart is similar, except that it does NOT use the weighting column!
 - A linear weighting scheme (+, -, 0 wrt a baseline design) will give equal weighting to attributes

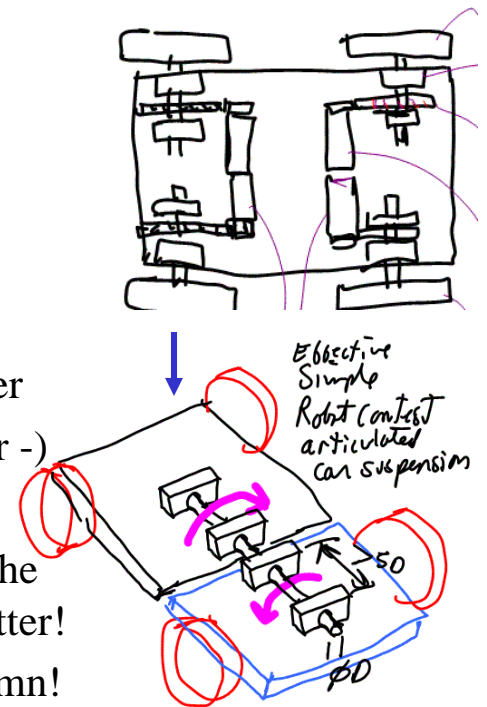

	A	B	C	D	E
1					
2					
3					
4					
5					
6					
7		Weight	Tilting Table	Peace Circle	Tilting Beam
8	Scoring variation	3	0	-1	0
9	Dynamic motions	2	0	0	1
10	Crowd appreciation	1	0	0	0
11	Manufacturability	1	0	1	0
12	Transportability	1	0	1	0
13	Scalability	2	0	0	0
14	Base for storage	1	0	1	0
15			0	0	2

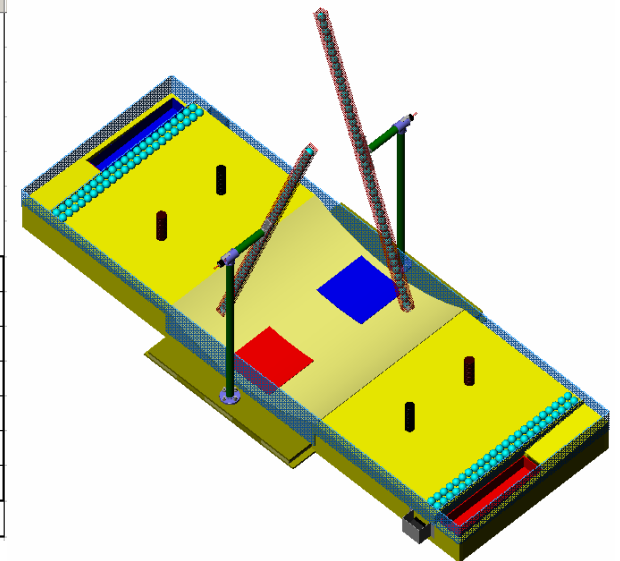

Intellectual Property

One of the primary features of many societies in which very creative people choose to live is that a person can say what they want, and own what they¹. The latter is the basis of *intellectual property* and is manifested with patent, trademark, and copyright law. The specifics of laws vary from country to country, but there are broad agreements between countries that enable inventors and companies that act expeditiously and wisely to succeed in an international marketplace. Countries' patent trademark and copyright offices' websites contain information on filing for patents and can be very helpful as they want to stimulate business and their economies.

In the United States, the first to conceive of an invention can own the invention if they file for a patent and it is granted. However, the patent must be filed within a year of public disclosure. But if the idea is disclosed publicly before a patent is filed, then no foreign patents can be applied for. The US law is meant to allow an inventor to present an idea for review before spending many thousands of dollars filing a "utility patent". The law allows an inventor to file a *provisional patent* to protect their rights in order to help inventors to still have a year to determine if their idea has merit and they should spend thousands of dollars on a patent attorney to file and then try to obtain useful claims. If an inventor has any intention of filing for foreign patents, they should thus file a US provisional patent before making their idea public. A provisional patent should include everything they think will be in the full utility patent, and be of similar format and quality, but it does not require carefully drafted claims. After filing a provisional patent, if new material is created, it can be included in the utility patent that is filed, within a year of filing the provisional, but it will have a priority date of the filing of the utility patent. Material from multiple provisional patents within a 12 month period can be included in a single utility patent. Filing a provisional patent is not considered by itself a public disclosure, but a utility patent and foreign patents must be filed within 12 months of filing for a provisional patent. A patent contains the following sections:

- TITLE
- Text providing brief summary of the problem area and the invention

- STATEMENT REGARDING FEDERALLY FUNDED RESEARCH: Weather or not federal funds were used in the development of this invention
- FIELD OF THE INVENTION: Short description of the field (area) of the invention
- BACKGROUND OF THE INVENTION: Background, description of the problem and prior art (related articles, products, and patents) and some of its shortcomings.
- OBJECTS OF THE INVENTION: A list of the principal objects, functions and attributes, of the invention. These objects can then be reflected in the claims.
- SUMMARY: A brief summary of the invention.
- DRAWINGS: A brief description of each of the drawings. Each drawing is numbered and each important feature shown in a drawing is given a number which is used in the discussion of the drawing.
- PREFERRED EMBODIMENT(S) OF THE INVENTION: Detailed description of the different embodiments of the invention. There can be many, but if there is a preferred embodiment, it must be described. In addition, when filed, the inventors must provide as much information as they have about the best mode they know of for practicing the invention. If they do not, and it can later be shown they withheld best mode information, the patent can be invalidated.
- CLAIMS: Claims start with a general (broad) independent claim and add more and more detail with dependant claims that build upon other dependant claims and an independent claim. The claims are essentially a recipe for creating the invention. It may be tempting to try and get as broad a claim as possible; however, if the patent examiner determines that the claim has been anticipated by prior art they find, then the claim will be rejected. The claim can be modified, however, if the patent issues and is then used to bring a lawsuit against an infringer, the *Festo* ruling can be used to invoke estoppel which means that the claim must be literally infringed. If a claim is issued without significant modification, then infringement can be found by the doctrine of equivalents, which means it can be infringed if a product accomplishes essentially the same function in essentially the same way with essentially the same results as claimed. Hence claims must be carefully crafted and the inventor and their attorney should not be too greedy.
- ABSTRACT: A concise summary of the invention and what it does.

1. See for example Thomas Jefferson's letter to Isaac McPherson Monticello, August 13, 1813

Intellectual Property

- www.uspto.gov has lots of useful information, e.g.,:
 - Under the Paris Convention for the Protection of Industrial Property, a treaty that provides a number of important rights for innovators, a patent applicant may file an application in one Paris Convention member country (the priority document), and within 12 months, file corresponding applications in other member countries, while obtaining the benefit of the first application's filing date. This 12-month period allows applicants to make important decisions about where to file subsequent applications to seek protection for their inventions. Paris Convention filings are a critical component in many applicants' global business and patenting strategies and represent a substantial portion of worldwide patent activity.

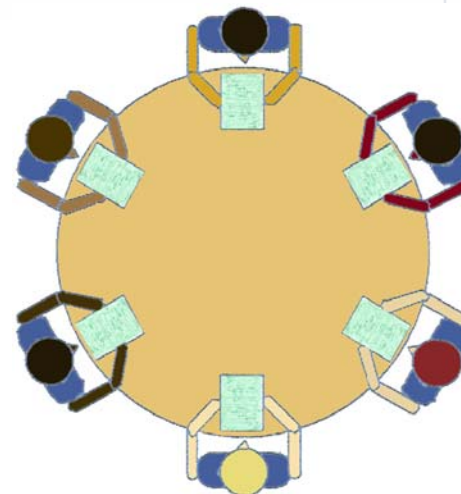

Professional & Personal Ethics and Moral Standards

There are many books, indeed volumes of law, that are intended to help maintain order, but even more important than obeying the letter of the law, is the need to have high moral and ethical standards. From respecting intellectual property, to respecting the rights and feelings of others, to always telling the truth and obeying the law, doing unto others as you would have them do unto you makes sense because what comes around goes around. How does one judge what is right and what is wrong? Because it is often easy to convince oneself of what is right, imagine that what you do is published on the front page of a newspaper along with your name as the one who did it. What would public opinion say? What would your sentence be?

With respect to intellectual property law, how would you feel if someone saw your new clever idea for a machine for a contest and copied it without first asking you for permission? How would you feel if a person, such as your boss or an aggressive colleague made a random obvious comment during your presentation to him/her and then they added their name to the patent?¹

Intellectual property goes beyond patents. It includes confidential information such as private business plans and strategies. How would you feel if someone took your confidential information and forwarded it to a competitor? What would you do if you anonymously received a competitor's confidential information? If someone received your confidential information, you would probably want them to be honorable and not look at it but instead return it to you along with information on how it came to them so you could stop future leaks?

Beyond intellectual property, what of the personal property that is oneself? How would you feel if someone made lewd comments about you or someone who you found undesirable came onto you continually? How would you feel if they did it to your loved one? Your child? Again, imagine that what you say or do is printed on the front page of the newspaper and that you are identified as the one who did it!

There are more subtle issues associated with behavior that can have a big impact on others and yourself. In a design review, for example, would you like it if someone made cutting caustic remarks about your ideas? Do you not like it when people instead make constructive comments about how your ideas could be made better? Imagine the consequences of your actions when your cutting remarks intimidate a shy quiet person who may have otherwise described an idea that could have led to your company being able to achieve market dominance? What happens if your actions suppress the idea that could have saved your company, and now you are looking for a new job because your company is no longer competitive?

Not only is it important for a person to act honestly and nicely, a person must also encourage others to do so too, and a person must try to nicely and constructively help others to grow too. If you committed some grievous error that made others think less of you, would you not want a friend to discreetly tell you about it so you could correct your actions?

No one owns another person either physically or mentally. Remember, if you have a bird, let it be free, and if it was meant to be, it will stay with you. Trying to emotionally control other never works in the end, and your time on this earth is finite, so do not waste it.

Coming full circle back to the technical, if you make a serious error which you later discover, what would you do if a loved one was to be using your product? What would you do if you found that someone else made a serious error that could cause harm to one of your loved ones?

At the end of the day, the month, the year, the decade, the century, the millennium.... for what do you want to be remembered for? Seemingly small events have a way of cascading in ways that one may not be able to imagine. Take the time to imagine and make reality wonderful for all.

1. Fortunately, the law says that each named inventor must be associated with at least one claimed element. If a person's name is added to an invention, yet they were not really an inventor, this can cause the patent to be invalidated. Keep good notebooks! This is where PREP and records of who said what during brainstorming can be especially useful.

Professional & Personal Ethics and Moral Standards

- Professional ethics:
 - Work hard and try to help create an environment where others can also do their work
 - Practical jokes and humor at the expense of others are never in good taste
 - If you see a problem, try to offer help and do not turn a blind eye
 - Always try to offer constructive criticism: end each statement with a +
 - Document what you do, and if a problem is discovered, keep raising it until it is addressed.



If you know who created this picture, please email slocum@mit.edu so appropriate credit can be given

- Personal ethics and Moral Standards
 - Assume what you do and your name will be on the front page of the newspaper...
 - Treat others with the same respect as you would like to receive
 - Brush your teeth, beware others' personal space...
 - Romance in the office can work, but ask what will happen if it ends...
 - Be discrete, perhaps ask a friend to enquire...NO means NO!
 - There should be no direct supervisory role, and not working on the same project
 - Check company policy and tell your boss ASAP!



Look for happiness all around,
and if you do not find it, create it!

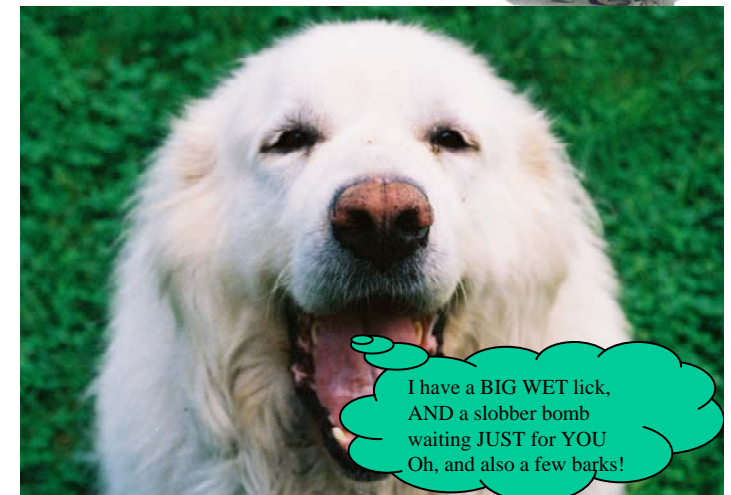

Safety!

All too often people walk around with binocular-butt: it seems everyone has 20/20 hindsight when it comes to safety. If only we could see and fix problems before they occur. Unfortunately, our vision is often blurred by schedules, budgets, and social pressure. And what happens if you try to resolve an issue and are continually rebuffed? In the end, whistle blowing is part of safety: if you observe or become aware of a safety problem and despite your best efforts to resolve the issue no one will listen, it might be time to go to the press.

Standards, as discussed earlier, can also help to make a design safe. There are also many reference books available that can help you learn how to design products that are not only safer from a catastrophic perspective, but also from a repetitive use damage perspective.¹

Safety is not just about the final product, safety is also of a concern when making the product. In the process of obtaining the desired shape of a part, sharp edges can form, grime can accumulate, and internal stresses can develop. Sharp edges are a safety hazard, increase assembly problems, and are sites for raised dents to occur when banged which could then later cause an assembly to jam or fail. And think about sharp edges on parts inside an assembly that can cut a user's hands if they reach inside or under the seat of a car for example.

There are so many things to consider and so many things that could be written, but three overall design-for-safety rules can serve as catalysts:

Design safety into the product itself. Do not design the machine and then figure out how to make it safe.

Design the product as if your life depended on it, lest as punishment for poor design you might be forced to work on the machine for the rest of your life.

1. See for example W. Woodson, *Human Factors Design Handbook*, McGraw-Hill Book Co.; and *The Principles and Techniques of Mechanical Guarding, Bulletin 197*, U.S. Dept. of Labor Occupational Safety and Health Administration.

Remember that people are generally careless with regard to safety and they will often push a machine to see how far they can get away with something.

An incident worth remembering regarding safety is the case in the early 1980s where two drunk men decided to pick up a lawn mower and use it to trim some bushes. The men lost their fingers and were awarded several million dollars because it was said the lawn mower manufacturer should have made the mower so that this could not happen. Lawn mowers now have a switch that stops the engine if the user takes his hands off the mower handle. But wait, what if the user uses wraps tape around the handle to hold the clutch lever? It seems that the manufacturer should install a vision system to watch the operator. Who cares if the mower that used to cost \$200 may then cost tens of thousands of dollars! Does this seem ridiculous and stupid? Well it is not half as ridiculous or stupid as the average user often acts with regard to safety. On the other hand, the design engineer should not use this story as a means to ridicule safety systems.

More recently, what about a safety switch that will instantly stop a spinning saw blade if it encounters flesh, but the saw is then destroyed. How reliable and expensive is the mechanism itself? Should manufacturers be forced to use it? What about safety guards on table saws that most seem to remove because the guards can obstruct the view of a skilled operator and thus cause a safety problem?

Up until the mid-1900s, safety systems were ignored on many machines, and many careful, intelligent operators lost life and limb. The design engineer must realize that people are human, and like all living things, even people deserve to be treated with compassion and respect. So if nothing else, design your machine so that you would feel comfortable with someone you love operating it.

Would you feel safe operating your machine if you were naked and locked in with your machine in the close confines of a closet (or phone booth)? Would you feel happy about your child or loved one operating your machine? And wear your safety glasses and tell others to wear theirs! And keep your fingers away from saw blades, because you should assume others might bump into you! And use a clamp or vise to hold work in a drill press, and tie back your hair and loose clothing....

Safety

- It should be obvious:
 - WEAR EYE AND EAR PROTECTION!
 - We each only have one set of body parts and one life to live
 - We all need to look out for each other
- The RISK column of FRDPARRC is also used to identify potential safety issues
- Humans are often defensive, and people will often make up what sounds like a reasonable excuse to justify their poor decision
 - It starts with kids:
 - “Dude, isn’t it dangerous to hold the pipe and fill it with match heads?”
 - “Nah, if the match heads start to go off, I will just throw the pipe away before it explodes”
 - It does not always end with adults:
 - “I am going to help my kid and his friends build a PVC potato canon like they saw on TV”
- Do for others as you would have them do for you

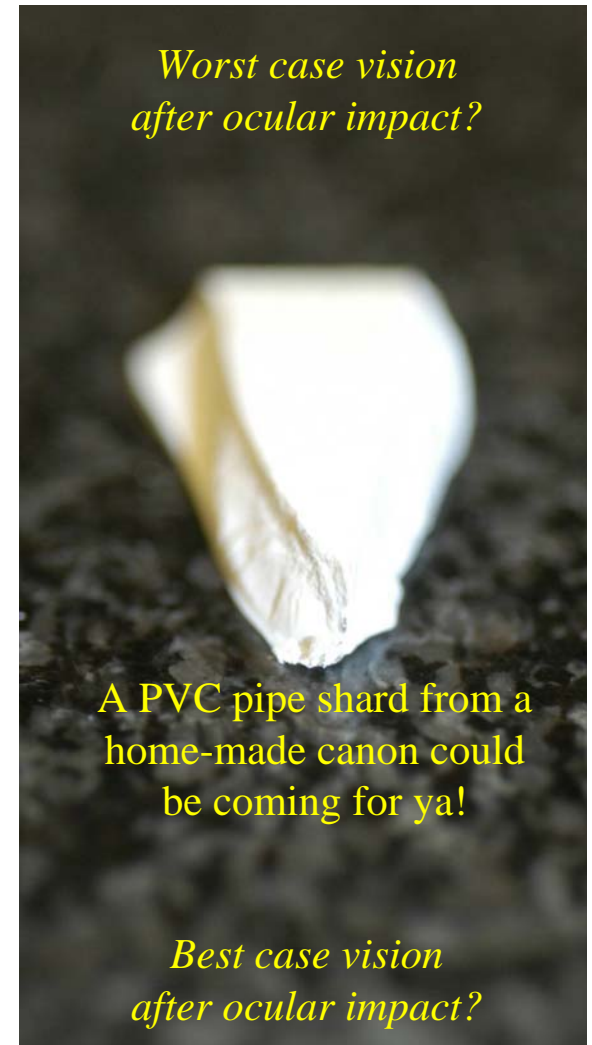

How Can You Help?

The New York Times ran a front page story on Sept. 26, 2003¹ that discussed how engineers tried to alert managers of the damage that a piece of foam insulation might have caused to the Shuttle Columbia's wing's leading edge. The incidents seem to be chillingly similar to the incidents surrounding the space shuttle Challenger disaster. "...the space agency should immediately get images of the impact area, perhaps by requesting them from American spy satellites or powerful telescopes on the ground. Mr. Rocha said he tried at least half a dozen times to get the space agency to make the requests. There were two similar efforts by other engineers. All were turned aside. Mr. Rocha (pronounced ROE-cha) said a manager told him that he refused to be a "Chicken Little".

Are engineers thus absolved from blame or guilt because they tried? Can they go to sleep at night knowing that it is the manager who will drown in hell? The manager may be drowning in hell in hot molten sulphur, but will you really be any happier standing on their shoulders?

And what about managers and construction supervisors? What of the Hyatt walkway disaster where what seemed like a simple substitution of two pieces of rod for a single piece turned into disaster as one nut on one rod was now forced to carry the weight of two walkways? Who approved the change without asking the structural engineer to verify the safety of the proposed design? How do we test engineers to make sure that when they are shown such a change do not see that it is not safe?

What about the tunnel roof panel collapse in the Boston Big Dig tunnel? An engineer expressed concern about using just a 2-bolt anchor, but the manager pushed back hard and said that unless it can be proven that it will fail, costs dictate that a two bolt system will be used. Is the engineer absolved from blame because they could not prove it? Should the engineer not have gone and found or invented a system that was 2x stronger but the same cost?

When lives are at stake, and a supervisor will not listen to a subordinate, should the subordinate go to the press and try to use a public forum to

raise the critical issues in an attempt to prevent disaster? And what about the future of the planet? Will engineers (and managers!) who do not write their representatives and who do not think of creative economical ways to make the world greener breathe any freer or get skin cancer any less? Perhaps the answer is blowing in the wind.

*Is it really a blessed thing to fight, / to try and spread what one thinks is right?
/ After spending \$500 billion of the people's money, / have there really been created any
lands of milk and honey?*

*With all of our human motions / we are killing our oceans. / With all that we
demand, / we are stripping the land*

*Because of all that we like to buy, / we are destroying the sky. / For humanity
to have a future for all may years, / hydrocarbons we must minimally burn*

*With trillions in debt, / with so many seeking jobs that do not make them fret, /
we need a big BOLD plan, / and an attitude that says yes we can!*

*With human resolve and economically installed green power, / those who take
advantage of others will cower. / With wind, water and sun we can all be energy inde-
pendent, / we can create a world with an environment resplendent*

*Let us all sing the praise of windpower at \$2/Watt. / Making green electric
power for the world may seem like a lot. / However it costs a lot less than going to war.
/ Now is the time to say to hydrocarbons no more!*

*It will require sound basic science, / to create strategies for energy compli-
ance. / Embodiment happens with design and manufacturing engineering. / Making all
these new systems will have workers cheering*

*There will be a rapid return on investment. / For as soon as we have hydro-
carbon divestment, / no longer for oil must billions of dollars a day flow. / Eudemonic
foreign policies can form and grow*

*It may seem too big and too expensive. / It may cause many to be apprehen-
sive. / But it's our future that is at stake. / We must do this or the planet will surely break*

*Harness the power of your endorphins and neurons and make a dif-
ference in the world.*

1. "Dogged Engineer's Effort To Assess Shuttle damage", by Jmes Glanz and John Schwartz, The New York Times, Friday, September 26, 2003, new England Edition, page A1.

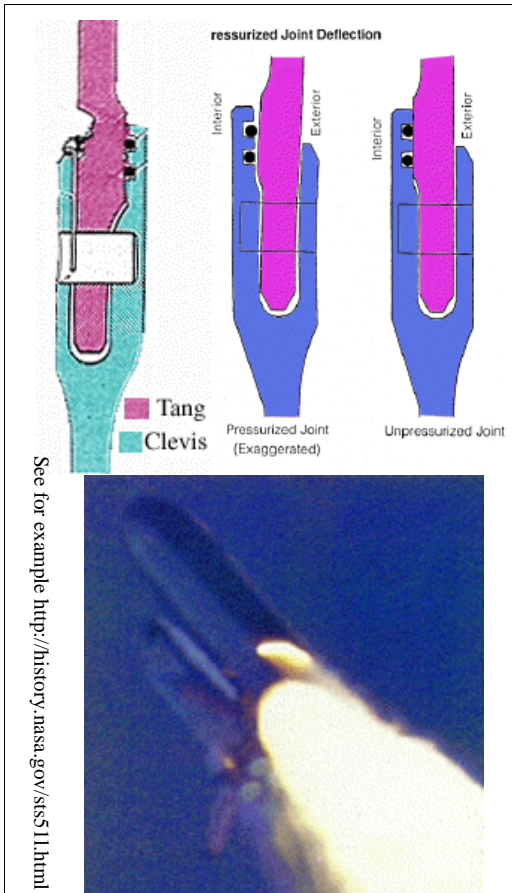

How Can You Help?

CNN.com / SCIENCE & SPACE

SEARCH The Web CNN.com

Home Page World U.S. Weather Business at CNNMoney Sports at 51.com Politics Law Technology **Science & Space** Health Entertainment Travel Education Special Reports

E-mail warned of descent disaster risk

Thursday, February 13, 2003 Posted: 2:12 PM EST (1912 GMT)

JOHNSON SPACE CENTER, Texas (CNN) -- An e-mail passed between NASA engineers two days before the fatal breakup of the space shuttle Columbia discussed worst-case scenarios involving tiles on the orbiter's underbelly that may have been damaged shortly after liftoff, specifically dealing with failures during descent.

Robert Daugherty, an engineer, outlined several scenarios in his e-mail to David Lechner, who worked with the shuttle's mechanical systems.

The area where something was seen falling off the shuttle.

Story Tools: SAVE THIS EMAIL THIS PRINT THIS MOST POPULAR

<http://www.cnn.com/2003/TECH/space/02/12/nasa.memo/index.html>

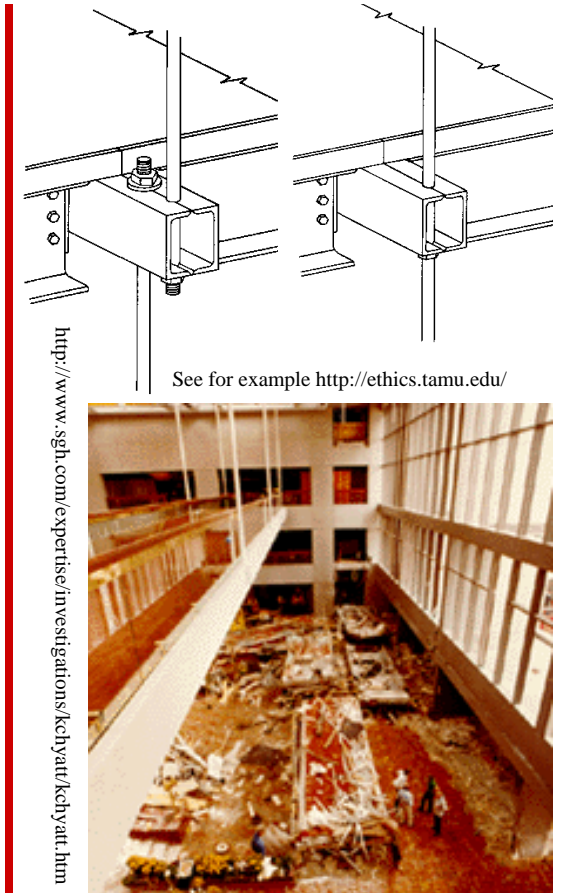

The New York Times National

NYTimes Home Site Index Archive Help Welcome, jwhite@mt Member Center Log Out

Go to a Section Go Site Search: Go

NYTimes.com > National

Dogged Engineer's Effort to Assess Shuttle Damage

By JAMES GLANZ and JOHN SCHWARTZ
Published: September 26, 2003

HOUSTON — Over and over, a projector at one end of a long, pale-blue conference room in Building 13 of the Johnson Space Center showed a piece of whitish foam breaking away from the space shuttle Columbia's fuel tank and bursting like fireworks as it struck the left wing.

In twos and threes, engineers at the other end of the cluttered room drifted away from their meeting and watched the

Advertisement

Michael Stravato for The New York Times
Rodney Rocha, a NASA engineer, conveyed the urgent message that the agency should seek satellite images that could show possible damage to the Columbia's wing.

<http://www.cbsnews.com/stories/2003/07/10/tech/main562542.shtml>

Evolution: *It Never Stops*

This chapter presented systematic methods for looking at a problem from many different perspectives including specific thought processes, such as *backwards steps* which was used to solve a difficult 3D geometric proof.

Experimentation was shown to be a powerful means to learn about a problem and to answer specific questions about a design or to test a hypothesis, especially when analysis is intractable. However, there is no excuse for not first trying to seek an analytical solution. In fact, experimentation led to Westheimer's Discovery: A couple of months in the laboratory can frequently save a couple of hours in the library.

Drawing, from stick figures to hand sketches to solid models, was shown to be a means of universal communication, but like any other tool, it must be used with an appropriate amount of effort. During the *strategy* phase, simple stick figures and sketches or block-type solid models are appropriate. A fully detailed model will likely cause you to lock onto a design too early. Sketch models, essentially 3D models made from cardboard or foam core, are a great way to "feel a design" and to play with it in the environment.

Research is a vital part of creating and developing ideas, because chances are there is a similar idea already out there, possibly in a different field, and there is no shame in scaling or evolving an existing idea. As long as it is not covered by a patent, you should take advantage of what others have already proven. If an idea is patented, consider getting a license.

Writing allows you to express your interpretation of what must be done, and then in a creative mode, envision how your machine will operate. The process of writing about your machine to communicate your ideas to others often leads to new insights!

Analysis is the parent of all design tools for it helps us to nurture and develop a design. Analysis keeps us from doing foolish things for which we might otherwise later slap our foreheads and cry out in anguish at our silliness. Like any good parent, it also encourages us to try things, as long as they are not dangerous, by highlighting parameters that have a lot of potential!

Evolving ideas is the method by which individuals first think about how to solve a problem, then they write down their three best ideas and bring them to a team evaluation. The team uses the Rohrbach process where each team member reviews each other team members' ideas and writes constructive comments on them. Then everyone reviews everyone else's comments before a team brainstorming session begins. During the first phase of brainstorming, no idea is disregarded, but potential problems with ideas and ideas for their possible solution are discussed. Finally, a weighted design comparison matrix is completed where the ideas with the highest potential are selected and any negative attributes are fixed by borrowing from other ideas which had corresponding positive attributes. We have now thus covered the basics of design process and methods for stimulating and managing creativity in individual and team modes. The rest of this book will focus on deep geek topics of the philosophy, physics, and practice of the design of machines and their *components*. Once again, the patterns will repeat, where the philosophies presented in Chapters 1 and 2 will enable you to develop your bio neural net to see how best to accomplish a design, and how to analyze it, either in your head or by creating a plan for formal analysis.

Remember, our goal is to be able to design a machine right the first time, in minimum time; and when people ask you why you like to design machines, you will be able to answer like Albert A. Michelson, the inventor of the interferometer, when he was asked "Why do you like to design machines?" to which he replied:

"It is the pitting of one's brain against bits of iron, metals, and crystals and making them do what you want them to do. When you are successful that is all the reward you want."

[Why do you like to design machines? How does your passion for designing machines relate to your passion for other activities such as sports, cooking, music, playing with Legos™, holding hands...?](#)

Evolution: *It Never Stops*

- Physically experimenting with the hardware while thinking about all possible variations can produce many creative ideas
 - Sketching, drawing, and solid modeling are powerful creativity catalysts
 - Much has been done by others: Learn from others' failures and successes
 - Writing down your thoughts and dreams can help you to see solutions
 - Analysis can identify areas of high (low) sensitivity and rapidly ascertain feasibility
 - Ideas can evolve rapidly when they are compared to others

- ***Stay Psyched and Passionate!***

- ***Never Stop!***

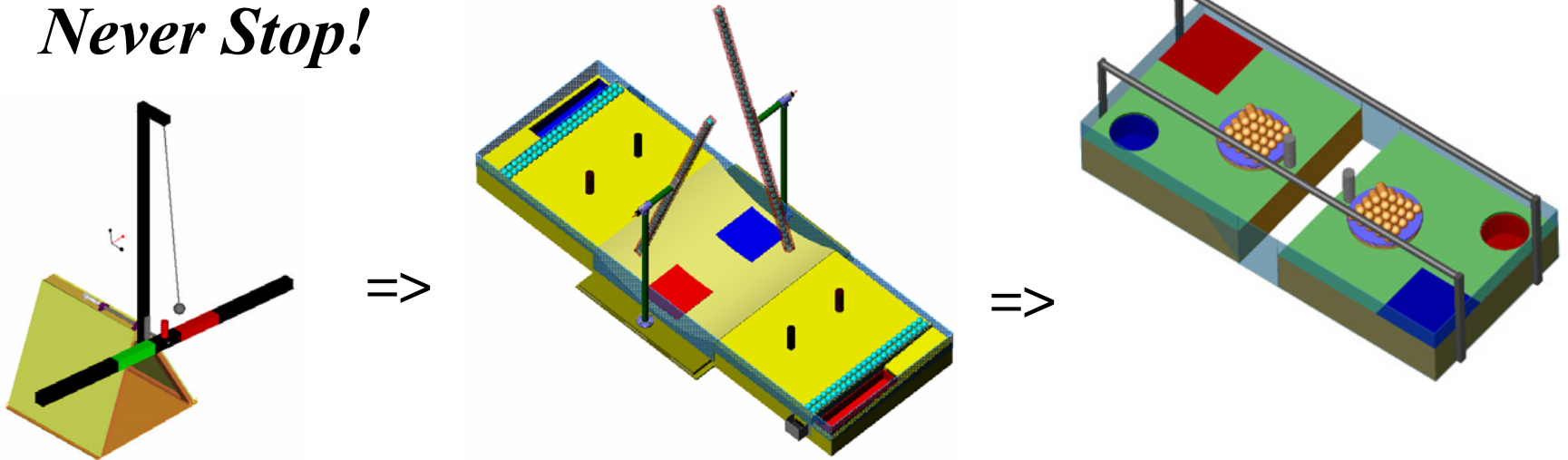

Topic 2 Study Questions

Which suggested answers are correct (there may be more than one, or none)? Can you suggest additional and/or better answers?

1. Truly creative people should not be hampered by schedules:
 - a. True
 - b. False
2. Truly creative people should not be concerned with budgets:
 - a. True
 - b. False
3. Truly creative people can be very difficult to manage because they do not want to be hampered by budgets and schedules:
 - a. True
 - b. False
4. Truly creative people who manage budgets and schedules are far more effective and loved and respected than those who do not:
 - a. True
 - b. False
5. A cohesive motivated team can easily make up for technical deficiencies amongst its members:
 - a. True
 - b. False
6. A strong team should ideally have individuals who are competent in all of the disciplines required to complete the project, or they should be authorized to acquire such members or appropriate consultants:
 - a. True
 - b. False
7. The best way to minimize design cost is to:
 - a. Form a team, brainstorm to generate solution ideas, form sub teams create prototypes, gather together again compare cost and performance data to select the best idea.
 - b. Form a team, agree on the problem, individually generate strategies, individually review each others' ideas, and then brainstorm to select the best solution strategies and concepts on which feasibility experiments can then be run.
 - c. It does not matter so long as the team is motivated to solve the problem
8. The relative amounts of time spent on developing a new idea are typically:
 - a. 1/3rd time on strategies and concepts, 1/3rd time on detailed engineering, and 1/3rd time on build-test-modify
 - b. 1/4 time on strategies and concepts, 1/4 time on engineering, and 1/2 time on build-test-modify
 - c. 1/2 time on strategies and concepts, 1/4 time on detailed engineering, and 1/4 time on build-test-modify
9. Managers should consider the cost of offsite development programs led by experienced creativity consultants as an essential part of new product development:
 - a. True
 - b. False
 - c. Bridges in Brooklyn are often available for low cost
10. Managers should consider first asking a team what they feel would truly enhance their creativity, and then work with the team to establish a project schedule and budget on which all team members sign off:
 - a. True
 - b. False
11. During the initial development of strategies and concepts, it is most important to
 - a. Experiment with hands-on-simple ideas
 - b. Create numerical simulations of ideas
 - c. Develop closed form-models of the system and ideas for further parametric study
 - d. Do whatever is best to achieve results the fastest
 - e. Combine experiments, modeling, and simulation to reduce development time and gain insight into critical parameters that will need to be optimized during the detailed development phase
12. *PREP* stands for:

- a. Precision Repeatable Engineering Process
 - b. Peer Review Evaluation Process
 - c. Ponder, Read, Evaluate, Proceed
13. Peer review of others' written ideas before a brainstorming meeting enables the team to:
- a. Make sure each individual has a chance to think about the problem on their own
 - b. Make sure each team member has had private time to think about the ideas of others
 - c. Keep a good record of who thought of what
14. Whenever you are reviewing the work of others:
- a. Just point out what is wrong, as it is their responsibility to fix the problem
 - b. Try to not be too critical
 - c. Point out every error and point-that-needs-clarification you find, AND make suggestions as to how to resolve the issues
15. It is vital that you learn to give and take constructive criticism because:
- a. Your competitors are never shy
 - b. You want to become a better person and designer, as well as help others become better persons and designers
 - c. You are likely to never advance if you are a twit
16. At a review presentation you are giving, a colleague viciously lashes out that you made a mistake:
- a. You counter attack with equal or more viciousness to teach them a lesson
 - b. You graciously disarm them and then if they actually have a good point you acknowledge the error and seek to fix it "Parting the deep waters I see that you have a good point that I will work on to resolve"; and if they are not correct you say "I do not see your point..." and then if time allows resolve it then and there.
- c. You start an argument with them about why what they said does not apply (regardless of whether or not it does) to save face
 - d. You make a note to next time make sure only decaf coffee and sugar-free donuts are served
17. If a patent is found that relates to a machine being developed, the engineer should:
- a. Check the expiration date on the patent
 - b. Check to see if the patent has been abandoned
 - c. Check to see if the assignee is a competitor
 - d. Alert the product manager as the possible interference and work with the team to develop alternate designs
18. Managers faced with a patent that may have claim to a project for which they are responsible should:
- a. Ask the legal department for advice
 - b. Ignore the patent and later feign ignorance
 - c. Develop countermeasures to handle the risk
19. Companies that find that a non-competitor's patent claims cover some aspect of one of their products should:
- a. Hire a crack team of lawyers because whoever spends more is likely to prevail in court
 - b. Investigate the potential for an amicable license and then use first-to-market and the precedent for validity of the patent as a market advantage
 - c. Ignore the patent, and then delay while trying to design around the patent claims
20. Companies that find that a competitor's patent claims cover some aspect of one of their products should:
- a. Hire a crack team of lawyers to first try to invalidate and/or prove non-infringement because whoever spends more is likely to prevail in court

- b. Evaluate market potential and investigate the potential for an amicable license by making note of the fact that very few companies will want to buy from a sole-source supplier
 - c. Use the patent as a catalyst to design a better (and patentable in its own right) alternative
 - d. Ignore the patent, and then delay while trying to design around the patent claims
21. When a manager is faced with a patent that may have claim to a project for which they are responsible:
- a. Ask the legal department for advice
 - b. Ignore the patent and later feign ignorance
 - c. Develop countermeasures to handle the risk
22. A good strategy is to file as many patents related to an area as possible so you can build a protective fence around yourself, or to contain a competitor:
- a. True
 - b. False
23. Filing many patents around an idea is referred to as “picket fencing”
- a. True
 - b. False
24. Companies that find that a non-competitor’s patent claims cover some aspect of one of their products should:
- a. Hire a crack team of lawyers because whoever spends more is likely to prevail in court
 - b. Investigate the potential for an amicable license and then use first-to-market and the precedent for validity of the patent as a market advantage
 - c. Ignore the patent, and then delay while trying to design around the patent claims
25. Companies that find that a competitor’s patent claims cover some aspect of one of their products should:
- a. Hire a crack team of lawyers to first try to invalidate and/or prove non-infringement because whoever spends more is likely to prevail in court
 - b. Evaluate market potential and investigate the potential for an amicable license by making note of the fact that very few companies will want to buy from a sole-source supplier
 - c. Use the patent as a catalyst to design a better (and patentable in its own right) alternative
 - d. Ignore the patent, and then delay while trying to design around the patent claims
26. Your boss says “we need to add Joe to the patent because it will make him feel like he is part of the team”, but Joe had nothing to do with the invention, so you:
- a. Say “OK” to keep the boss happy
 - b. Say “that’s a great idea, because in fact the patent office requires each inventor to be associated with specific claims else the patent can be invalidated, so let’s go through the patent and make sure we did not miss any other team members”
 - c. Say “WHAT, ARE YOU CRAZY, JOE IS AS USELESS AS A RUBBER SWAB HANDLE”
27. The goal of a competitive business should be to:
- a. Bury the competition by whatever means it takes
 - b. Focus effort and resources on creating and servicing a better product
 - c. Competition is best for the long term growth of the economy as a whole, so embrace it
28. You receive a competitor's business plan in an unmarked envelope, and you:
- a. Secretly read it and act to counter it
 - b. Do not read it, but instead send it to your competitor’s CEO with a letter saying someone sent it to you, but you did not read it, and you hope that your two companies can be friendly competitors, and that you both must tell employees such practices (giving or receiving of confidential information) will NOT be tolerated.
 - c. Read it and act on it as if nothing is unusual because it is not your fault if your competitor has leaks

29. Valuable “gifts” from vendors (and giving them) are important “business catalysts” to give and receive:
 - a. True
 - b. False
30. A reporter asks you what you think of someone else's product or program, which you actually do not feel very good about, and you:
 - a. Take the opportunity to honestly, in your opinion, describe its shortfalls
 - b. Say “no comment”, and thereby imply you hate it
 - c. Say to yourself “if you cannot say something nice about something, then say nothing at all” and instead reply “I am happy to tell you about the attributes of my stuff, and then let your audience compare and draw their own conclusions”
31. All too often, someone says something to a reporter, and then they feel that their view is misrepresented and then misunderstood
 - a. True
 - b. Build a door for your mouth and bolt it
32. You read an article or an editorial that you feel is highly critical of you, and reasonable options are
 - a. Write a counter editorial or article that takes the other view apart piece-by-piece
 - b. Write a “I beg to disagree” letter pointing out primary specific facts that are a matter of public record, and then invite the person to publicly debate the rest if they have faith in the accuracy of their allegations
 - c. Contact an ombudsperson to mediate
 - d. If all else fails, and you are not a public figure, see a lawyer about a libel suit
33. You are told by a friend that they said they heard that she said he said you are a flaming twit, and possible options to consider include:
 - a. You aggressively counterattack
 - b. You confront the supposed insulter
 - c. You ask your friend to pass it back up the line that you suggest a meeting to iron out differences
 - d. You confront the supposed name-caller
 - e. You try calm personal contact with the supposed name caller to try and find out if you share common interests..., and if that fails, you ask an ombudsperson to help mediate
 - f. You ignore the entire conversation
 - g. You do a careful self-evaluation to try and determine why someone may have this view of you, and think about evolving
34. You carefully deterministically design a module according to schedule, but management gives praise to those who finish fast and sloppy (and then start iterating) and then complains you not fast enough (even though you are on schedule), so you:
 - a. Nicely point out that you are on schedule, and that you do not expect to have to iterate and that your design will be fully documented
 - b. Suggest that the project should keep track of the long term success rate of iterative versus deterministic design approaches (including performance of the product after it has been shipped)
 - c. Send an email to your boss, and copy his boss, telling them why they have no clue how to manage a project
 - d. Start an informal lunchtime seminar for employees to share design experience so as to learn from experience and help build institutional memory
35. Your company outsourced a design, you were not allowed to have any input, and now it does not work and management tells you its your job to make the design work:
 - a. Refuse to work on the project
 - b. You tell your boss “I told you so” as you hand in your resignation because you have found a better job
 - c. Write up and send your boss a “Harvard Business Review” type case study where you show the outsource design, the problems it has, the fixes you identified, and the savings in time that would have been realized if it had been designed in-house with the advantage of all the company’s expertise

- d. Start an informal lunchtime seminar for employees to share such stories not to gripe, but to learn from experience and help build institutional memory
36. Reverse engineering (taking apart a competitor's product) is unethical
 - a. True
 - b. False
 37. Really smart engineers do not have to take apart their competitor's machines to know that are better:
 - a. True
 - b. False
 38. Using the results of reverse engineering can get you in trouble if you learn from a competitor's design and copy, but you do not realize they have a patent.
 - a. True
 - b. False
 39. Open-source software that excludes commercial application can be ignored because no one will ever see it deep in the machine's source code:
 - a. One day it will be found, perhaps in a patent lawsuit, and you have wish you had read this section more carefully
 - b. False: who cares?
 40. Managers should consider the personal lives of employees when forming a team:
 - a. Its best to try and put singles on a team so they will form relationships and get married and then become more stable company employees
 - b. Its best to put people on a team who have been married for a long time because they will be more likely to stay late and work harder
 - c. Its best to mix single and married people so they will want to mingle after work and thus may be inclined to get more work done
 - d. Social engineering does not work and managers should build teams based on abilities
 41. If a coworker makes unwanted overtures toward you, best first options include:
 - a. File a lawsuit
 - b. Tell them "no thank you"
 - c. Tell your supervisor
 - d. Ask a mutual friend to please discretely alert them to the fact you have other personal commitments, and office relationships are not a good thing, and if this does not work, then tell your supervisor
 42. If you observe inappropriate harassment-type behavior, you should:
 - a. Tell your supervisor
 - b. Tell the person to stop
 - c. Mind your own business
 - d. Ask the person being harassed if they want you to help
 43. If you have uncontrollable desire to get better acquainted with a coworker, you should:
 - a. Forget it and start taking more cold showers
 - b. Ask a mutual friend to see if such interest might be welcomed
 - c. It's nobody's business but yours, so go for it!
 44. If you are to become involved with someone in your company, its best to:
 - a. Only ask out your subordinates so you can then make them do more work and thus also win company productivity awards
 - b. Only ask out superiors so you can get them to give you company awards
 - c. Only ask out those of equal rank
 - d. Only ask out those with whom you will not have a conflict of interest, and then make sure your supervisors are aware of the relationship
 - e. Advertise the fact that you are dating so other people will stay away
 45. If your advances (to someone with whom you will not have a conflict of interest) are welcomed, you should

- a. Tell your boss about the relationship so as to avoid potential conflict of interest issues
 - b. Be discrete and keep your relationship outside the company
46. Emails and memos:
- a. Can and will be used against you
 - b. Never really go away
 - c. Are a good means to document a design to later establish invention priority
47. After you write that critical abusive email:
- a. Hit "send" write away so you will not be tempted to wimp out
 - b. Send it to yourself ONLY and pretend you are the recipient so you can read it later and see how you would feel if you received such an email.
48. Honesty is the best policy and should always be practiced from day 1 of a project
- a. True
 - b. Not always
49. Your personal morals and ethics are far more important than any job:
- a. True
 - b. False
50. What comes around, goes around and cheaters never prosper (for long):
- a. True
 - b. Not always
51. Safety features are not related to machine performance and therefore can be put off until the technological heart of the machine has been developed:
- a. True
 - b. False
52. Unless a machine is designed so people feel safe using it, it will probably not be successful:
- a. True
 - b. False
53. Safety standards can play a critical role in defining work envelopes and thus may also have a critical impact on the machine's technological detail:
- a. True
 - b. False
54. Design things as if YOU had to use them everyday yourself:
- a. True
 - b. False
55. The right ways to "blow the whistle" include:
- a. Speak with your supervisor
 - b. Send anonymous memos to appropriate people with the power to resolve the issue
 - c. Anonymously tip off the press and let them do the dirty work
 - d. Hold a press conference
56. If you become aware of a potentially harmful event (e.g., the Challenger space shuttle O-ring disaster), you should:
- a. Try to work within established company procedures for handling such events, and be satisfied you did your best
 - b. Try to work within established company procedures for handling such events, and keep your eye on the clock, and have a contingency plan for using the press or whatever it takes as a last resort to prevent the harm
 - c. Ignore it and feign ignorance because its none of your business, and you do not know them enough to get involved
 - d. Blame your superiors so they get fired and you move up the ladder!
57. If a member of your team is not pulling their own weight, the best thing to do is:
- a. Ignore it, because if you complain, you will be labeled a whiner
 - b. Ignore it, because their failure will be noticed by the team leader who is responsible
 - c. Discuss the issue with others on the team who are working hard to see if they concur, and then as a group speak to the team leader

- d. Try to talk to the person and see if there is anything you can do to help them become a stronger team member
58. A colleague makes a practice presentation to the group the night before presentation to the boss, and you notice some fundamental, but fine-point conceptual issues with some of the slides, so you:
- a. Ignore the issue because only a geek like you would ever notice
 - b. Ignore the issue because only a geek like you would ever notice, and if they were not smart enough to get it right, it serves them right!
 - c. Raise the issue, in a nice way such as by saying “only a geek like me would notice but I see a problem with the conniption pin angle”
 - d. Raise the issue, in a nice way such as by saying “only a geek like me would notice but I see a problem with the conniption pin angle, perhaps it could be inverted, and let me know if you want some help”
 - e. Wait to send them a private email later
 - f. Privately tell the boss your colleague is a fool
59. You see folks playing with a “canon” made from PVC pipe for shooting tennis balls... and you KNOW from this book that PVC is a brittle material and should never ever be used for pressurized gas systems (see page 7-26), so you:
- a. Ignore the issue because only a geek like you would ever notice
 - b. Ignore the issue because only a geek like you would ever notice, and if they were not smart enough to get it right, it serves them right!
 - c. Tell the kids how PVC shatters and sends shards flying that can blind and maim
 - d. Darwin rules, so you walk away and ignore them
60. They start to argue that they got the design off the internet, so you:
- a. Ignore the issue because only a geek like you would ever bother to try and talk sense into them.
 - b. Ignore the issue because if they were not smart enough to listen the first time, it serves them right!
 - c. Explain to them how you can find anything you want to on the internet, including facts such as the Earth is flat, and our ancestral space alien fathers will be here tomorrow to make everything OK!
 - d. Darwin rules, so you walk away and ignore them
61. They continue to argue that they are using schedule 80 pipe which is real strong, so you:
- a. Explain to them that just a scratch can be a stress concentrator, and the thick pipe makes for even higher velocity shards when the higher pressures make it blow!
 - b. Darwin must rule, so you walk away and ignore them
62. You see a design that violates common safety practices:
- a. Go as high as you need to up the responsibility chain to alert someone who can take action to fix the problem
 - b. Its not your problem, you have your own deadlines to worry about
63. Passive safety methods (warning labels) are often good enough for many types of products:
- a. True
 - b. False
64. Active safety methods (guards and lock-outs) are rarely needed:
- a. True
 - b. False
65. You are in an arcade and see a reciprocating choo-choo ride for kiddies that oscillates back and forth, but on the back-stroke it comes within a few inches from the wall. You tell the manager, but he does nothing about it, so you:
- a. Try to contact someone higher up
 - b. Unplug the machine and tie the cord in a knot
 - c. Do nothing, its not your business
66. The manager calls the police and a tough cop comes and starts to aggressively question you and threaten to arrest you for damaging personal property:

- a. You thank the officer for his rapid attention, quickly explain that a child could be crushed, and ask him to arrest the manager for violating a plethora of federal safety codes and for endangering children
 - b. Become meek and mild and make up excuses and try to get away
 - c. Tell him to go finish his donut and mind his own business
67. Acceptable ways to “blow the whistle” include in order of effort:
- a. Speak with your supervisor
 - b. Send anonymous memos to appropriate people with the power to resolve the issue
 - c. Anonymously tip off the press and let them try to help
 - d. Hold a press conference
68. If you become aware of a potentially harmful event (e.g., the Challenger space shuttle O-ring disaster), you should:
- a. Try to work within established company procedures for handling such events, and be satisfied you did your best
 - b. Try to work within established company procedures for handling such events, and keep your eye on the clock, and have a contingency plan for using the press or whatever it takes as a last resort to prevent the harm
 - c. Ignore it and feign ignorance because its none of your business, and you do not know them enough to get involved
 - d. Blame your superiors so they get fired and you move up the ladder!